

# Pinhole Network Camera

Installation Guide

V1.0.0

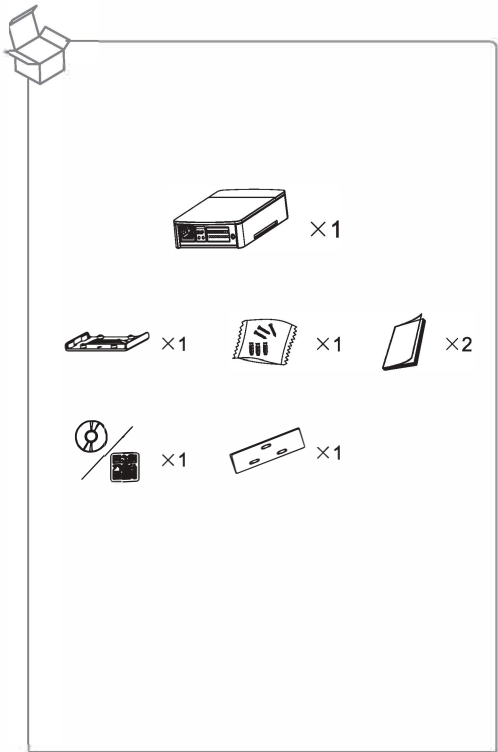

1.1

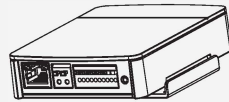

1.2

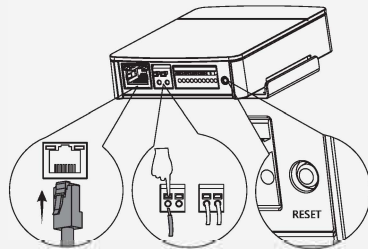

1.3

Optional

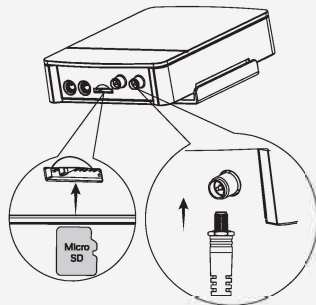

2.1

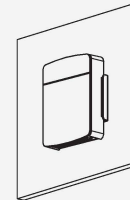

2.1.1

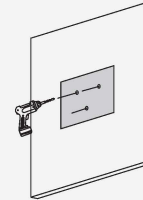

2.1.2

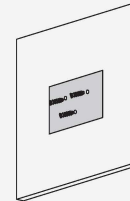

2.1.3

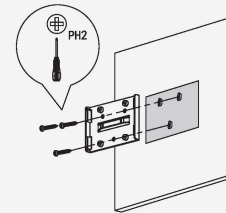

2.1.4

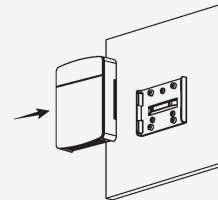

2.1.5

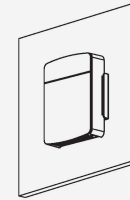

2.2 a

Optional

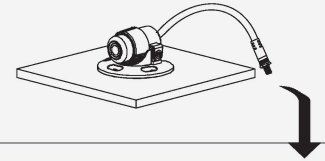

2.2.1 a

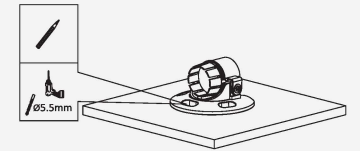

2.2.2 a

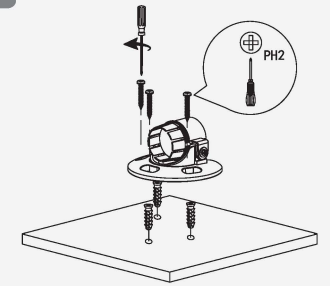

2.2.3 a

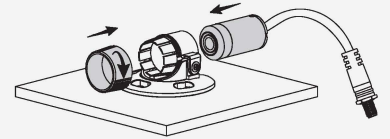

2.2.4 a

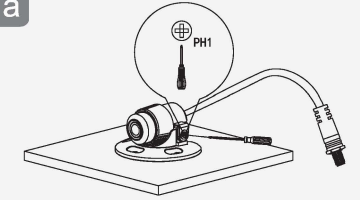

2.2.5 a

