

# SECURVIEW™

VICTORY SERIES

## Professional HDCVI Surveillance

Product Reference Guide



Experience your moment of victory.™



**SECURVIEW**



## Specialists in professional surveillance upgrades, delivering convenience and peace of mind through compatibility.

The Securview Victory Series™ is the best choice for high definition video over coax surveillance for residential, small to medium business, commercial and enterprise applications. The Victory Series offers high performance video surveillance for peace of mind, with unmatched cross compatibility for convenience and cost effectiveness.

With the Victory Series, Securview grants more people access to the security, efficiency and peace of mind offered by high resolution CCTV surveillance.

Purpose built for analogue surveillance upgrades, the Victory Series delivers far greater image resolution than that of its analogue predecessors across the same coaxial cable infrastructure. Cameras and recorders are also cross and backwards compatible with analogue and other coaxial video transmission technologies.

This makes the Victory Series the winning solution for surveillance upgrades on a budget, for staged upgrades, and for complex surveillance upgrade.

The Victory Series is available in 4 to 32 channel systems. They are accompanied by a wide range of professional surveillance cameras, accessories and software. These HD video over coax solutions are perfect for small projects through to large commercial, public sector and government level applications.

Experience your moment of victory. Transform your surveillance experience by upgrading to high definition with the Securview Victory Series.

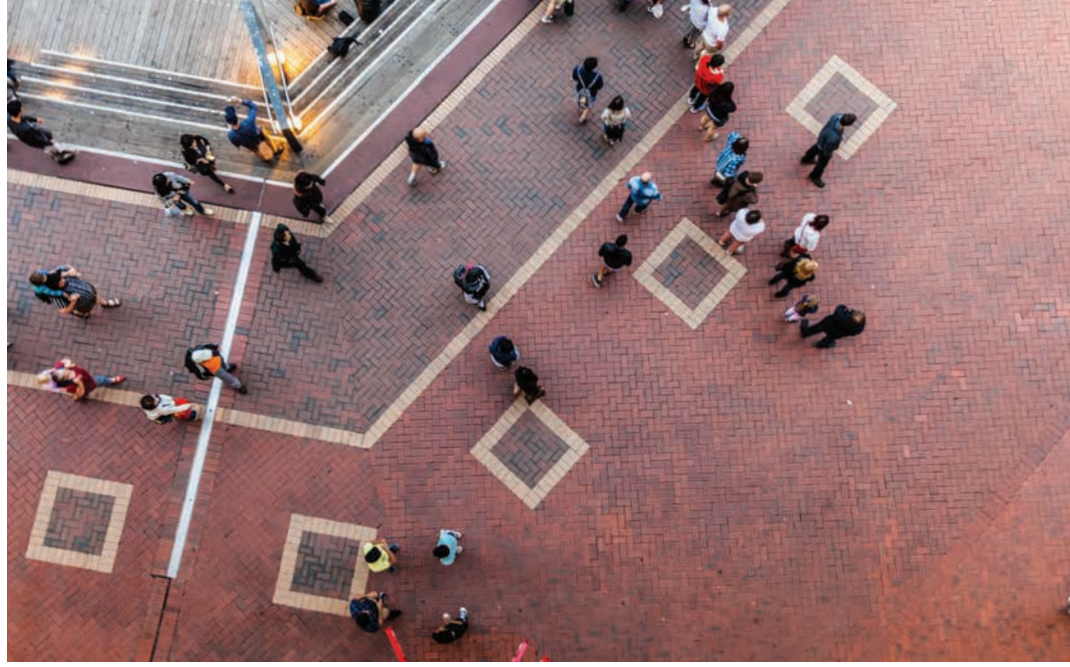

# Contents | Securview Victory Series™ Product Solution Guide



**Ultimate HDCVI DVRs**  
The best in performance with unparalleled record, backup & storage functionality.



**Professional HDCVI DVRs**  
High cross compatibility DVRs with support for up to Ultra HD resolution cameras.



**Ultimate HDCVI Cameras**  
Ultra HD resolution cameras, with a multitude of professional features.



**Professional Motorised HDCVI Cameras**  
Easy image configuration with motorised varifocal lens HDCVI surveillance cameras.



**Professional Fixed HDCVI Cameras**  
A wide range of high quality fixed lens and motorised lens HDCVI surveillance cameras.



**Specialist HDCVI Cameras**  
Create tailored surveillance solutions with HDCVI PTZ, fisheye and pinhole cameras.



**Mobile HDCVI Surveillance**  
Full HD vehicle surveillance with a variety of accompanying mobile HDCVI cameras.



**Surveillance Accessories**  
Test systems, extend display output and expand the reach of your HDCVI surveillance.



**Remote View Software**  
Desktop and mobile remote view clients so you can stay connected around the clock.



**Feature Glossary**  
Common HDCVI surveillance terms used within this product reference guide.



# Ultimate Series HDCVI Digital Video Recorders

## Series Overview

Securview™ Ultimate Series HDCVI DVRs are the ideal choice for large scale analogue surveillance upgrades.

DVRs feature powerful Intel processors and excellent backwards compatibility for existing coax and IP camera technologies. High capacity storage delivers peace of mind with potential for months of recorded footage.

Fully integrate, expand and maximise your existing surveillance system with the Ultimate Series.

## Model Reference

SKU	Description
CVR16ULT	16 Channel Ultimate HDCVI Synergy DVR



### Stream up to Ultra HD

Capture footage at 4K / Ultra HD with up to 3840 x 2160 resolution.



### Months of Stored Footage

Expand HDD capacity up to 80TB with eight SATA HDD bays in Ultimate DVRs.



### Intelligent Video Systems

Impressive CCTV features with tripwire, face detection, people counting & more.



### Long Camera Runs

Expand your HDCVI cameras to coaxial cable up to 700m (over RG59).



### Multiple Backup Options

Save footage via your network, USB drive, external HDD or internal DVD burner.



### Ultra HD / 4K Video Display

Output video to your display via HDMI (Ultra HD), VGA or BNC (TV) video output.

## Series Highlights

### Expand your surveillance reach with compatibility for up to 64 IP cameras

Extend CCTV surveillance systems even further by connecting up to 64 IP cameras to Ultimate Series DVRs.

- Record up to 16 HDCVI cameras combined with 64 additional IP cameras to create large scale CCTV surveillance systems
- Run HDCVI cameras at a distance of up to 700m over a single coax cable (RG59)



### 8 bays of storage capacity for a maximum of 80TB of HDD storage

Expand your CCTV surveillance installs with storage capacity up to 80TB, providing opportunities to add more cameras to large scale upgrades.

- 8 x SATA ports for up to 80TB of storage
- Backup footage via USB, external hard drive or DVD burner



### Integrate external alarm triggers with DVR alarm input/output support

Create a comprehensive alarm surveillance system with Ultimate series DVRs by connecting up to 16 alarm devices including: motion detection, reed switches, and more. Also connect up to 6 alarm output devices such as sirens.

- Alarm input/output for any HDCVI or IP camera
- Receive instant alerts via push/e-mail notifications and alarm timestamps in playback footage

### The best in cross compatibility with Victory Synergy camera support

Ultimate Series DVRs support video inputs from analogue as well as other major coaxial transmission technologies (HDTV & AHD) and external IP video inputs up to 12.0MP.

- Include any existing CCTV surveillance cameras
- Ideal for multi-staged CCTV upgrades or CCTV upgrades on a budget





# Best in cross compatibility.

## Ultimate Series: 4.0MP HDCVI Synergy DVR available in 16 channels

Ultimate Series DVRs offer the greatest features of any Securview Victory Series DVR. This includes high resolution recording, large HDD storage capacity, Synergy compatibility and support for up to 64 additional IP video inputs.

- Records up to 4K/8.0MP at 12fps (HDCVI, channels 1 and 9 only), 4.0MP at 15fps / 1080p at 25fps (HDCVI, HDTV, AHD) and 960H (analogue) at 25fps
- +64 additional IP channels up to 12.0MP/256Mbps
- 8 x SATA ports for up to 80TB total HDD capacity
- 2 x RJ45 (1000M) ports and alarm and audio I/O
- 2 x HDMI (1 x up to 4K) inputs & VGA video output
- Backup via USB, eSATA, or DVD burner (optional)
- Smart search, people counting & face detection
- Configure remote view in seconds via QR code



**4K/Ultra HD Live View + 2CH Record**



**Add up to 64 IP video inputs**

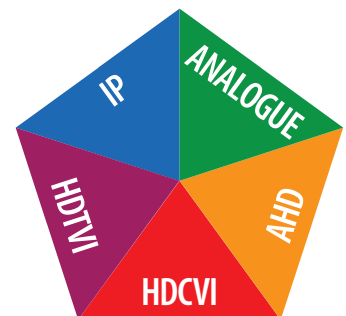

**Victory Synergy Compatibility**



Model	CVR16ULT
Main Processor	Intel Core Processors
Operating System	Embedded Linux OS
Video Input	16 channel BNC
Camera Configurations	Coaxial: 16 channels up to 4.0MP/15fps (HDCVI, HDTVI, AHD), Channels 1 & 9 up to 8.0MP/12fps, 960H/25fps (analogue) Network: Add 64 channels up to 12.0MP / Max 256Mbps Incoming Bandwidth
Audio In/Out	16 channel BNC / 1 channel BNC
Two-way Talk	1 channel input / 1 channel output BNC
Video Output	2 HDMI (1 x up to 4K/UHD resolution) / 1 VGA / 1 TV (BNC)
Display Resolution	3840 x 2160 / 2560 x 1440 / 1920 x 1080 / 1280 x 1024 / 1280 x 720 / 1024 x 768
Display Split	1/4/8/9/16/25/36
OSD	Camera title, time, video loss, camera lock, MD & recording
Privacy Masking	4 rectangular zones per camera
Maximum Resolution	8.0MP (3840 x 2160) / 4.0MP (2560 x 1440) / 1080p (1920 x 1080)
Frame Rate	Main: 8.0MP (1~12fps, channel 1 & 9 only) / 4.0MP (1~15fps) / 1080p (1~25fps) Sub: D1 (1~25fps)
Video Compression	H.264+ / H.264
Bit Rate	1~12288Kbps per channel
Record Modes	Manual / Schedule (Regular [Continuous], MD, Alarm) / Stop
Record Interval	1~60 min (default: 60 min) / Pre: 1~30s / Post: 10~300s
Alarm Input / Output	16 channel input / 6 channel relay output
Trigger Events	Recording; PTZ; predefined tour; alarm out; push video notification; email notification; FTP upload; snapshot, internal buzzer; and screen tip overlay
Video Detection	MD zones: 396 (22 x 18) / Video loss / Camera blank
Playback Sync	1 / 4 / 9 / 16
Search Modes	Time/Date; Alarm; Motion detection; Exact search (to the second); Smart Search
Intelligent Functions	Smart Tracking, Face Detection, People Counting
Backup Modes	USB Device / eSATA Device / Internal SATA burner (optional) / Network
Ethernet	2x RJ-45 port (10/100M/1000M)
Network Functions	HTTP, IPv4/IPv6, TCP/IP, UPNP, RTSP, UDP, SMTP, NTP, DHCP, DNS, PPPOE, DDNS, FTP, IP Filter, SNMP, P2P, Alarm Server
Max. User Access	128 users
Remote View	iOS (iPhone, iPad), Android devices
Internal HDD	8 SATA Ports, up to 80TB total
USB Interface	4 x USB ports (2 x USB2.0, 2 x USB3.0)
Auxiliary Inputs	1 x RS232 port (PC comm. & keyboard) / 1 x RS485 (PTZ control) / 1 x RS422 (keyboard) / 1 x LOOP (HDCVI/Composite 8/16 BNC)
Power Supply	100 ~ 240VAC, 50/60 Hz
Power Consumption	<40W (without HDD)
Operating Environment	-10~55°C / 10~90%RH / 86~106kpa
Dimensions	440mm x 455mm x 95mm (2U)
Weight	8.25kg (without HDD)

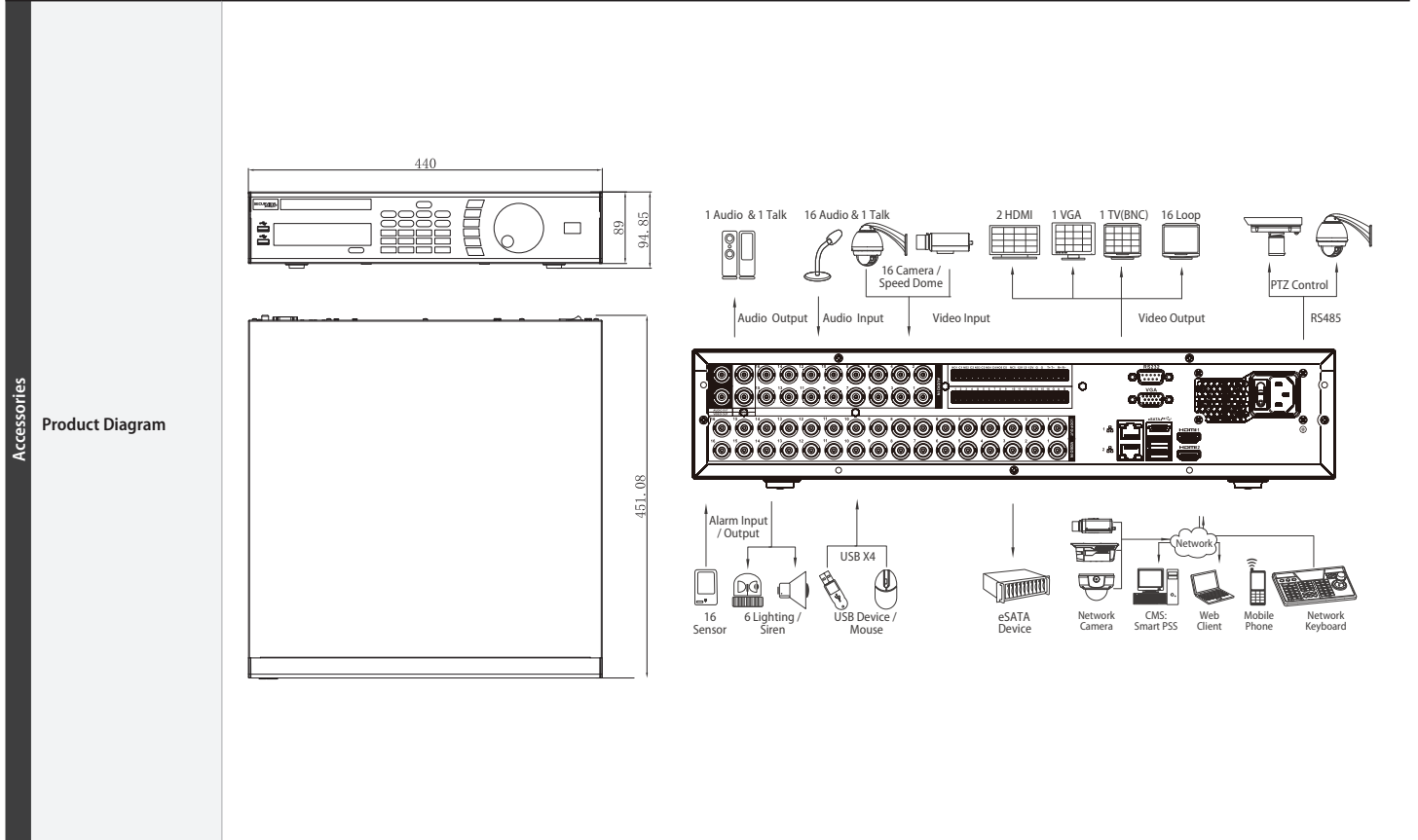



# Professional Series HDCVI Digital Video Recorders

## Series Overview

Securview™ Professional Series HDCVI DVRs are the perfect solution for upgrading analogue CCTV surveillance systems for small to medium sized businesses. Monitor surveillance remotely via smartphone, tablet, or PC.

The series features Smart Search & Face Detection, saving time on manually searching and reviewing playback footage. Victory Synergy allows for compatibility with a variety of video formats including: IP, Analogue, AHD, HDCVI and HDTV. I.

Professional Series DVRs are perfect for multi-staged upgrades & upgrades on a budget.



### Stream up to Ultra HD

Capture footage at 4K / Ultra HD with up to 3840 x 2160 resolution.



### Large Storage Capacity

Store over a month of recorded footage with up to 80TB internal storage.



**700M**

### Expand up to 700m

Connect HDCVI cameras to coaxial cable up to 700m.



### Scalable CCTV Systems

Recorders to suit installations of any size, in 8, 16 and 32 channel models.



### Multiple Backup Options

Save & backup footage on a local area network or external USB device.



### Multiple Backup Options

Display HD video output via HDMI or VGA.

## Model Reference

SKU	Description
CVR8PRO3	8 Channel 8.0MP HDCVI Synergy DVR
CVR16PRO3	16 Channel 8.0MP HDCVI Synergy DVR
CVR32PRO3	32 Channel 2.0MP HDCVI Synergy DVR

## Series Highlights

### Smarter HDCVI surveillance with Intelligent Video Surveillance (IVS)

Customise your DVR by setting up IVS rules. Set up virtual tripwires, unauthorized area intrusion and even missing & abandoned object detection.

- Easily search footage by IVS rule, including Face Detection, Tripwire & Abandoned/Missing Object
- Receive CCTV notifications on IVS rule violations
- Set cameras to pan, track & more on IVS trigger



### Remote view in a flash with QR code smartphone setup

Connect your Professional Series DVR to your smartphone in an instant with easy setup via QR code.

- Simply scan to connect your phone
- Live view, playback, PTZ & more
- iOS & Android devices supported



### Find important video footage faster with Smart Search and Face Detection

Search playback footage by captured face, or configure an area for motion detection to search footage with any activity in the scene.

- Set motion detection to enable Smart Search
- Set recorder to log and timestamp any face detected
- Search footage by detected & logged faces

### The best in cross compatibility with Victory Synergy camera support

Ultimate Series DVRs support video inputs from analogue as well as other major coaxial transmission technologies (HDTV & AHD) and external IP video inputs up to 8.0MP.

- Include any existing CCTV surveillance cameras
- Ideal for multi-staged CCTV upgrades or CCTV upgrades on a budget





# Incredible CCTV upgrades.

Professional Series: 1080p, 4.0MP & 8.0MP HDCVI DVRs, available up to 32 channels

Experience 4K/Ultra HD broadcast quality surveillance over coax. Rapidly transform low-resolution surveillance into high performing HD CCTV with full support for IP & analogue video inputs, all using existing coaxial cabling.

- Record up to UHD/4K/8.0MP (3840 x 2160) at 7fps / 4.0MP at 15fps (HDCVI) and 960H at 25fps (analogue)
- Add additional IP channels up to 8.0MP resolution
- Up to 8 x SATA ports for 80TB total HDD capacity
- HDMI (up to UHD/4K) & VGA simultaneous video output
- Backup via external USB device or local network
- Remote view for iOS & Android devices
- Configure remote view in seconds via QR code



**Ultra HD Recording Over Coax**

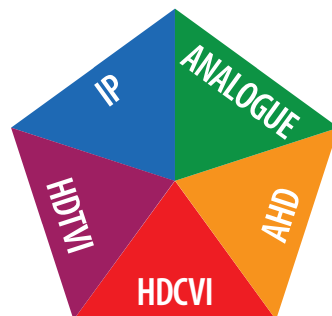

**Victory Synergy Compatibility**



**Remote View via QR Code**

Model	CVR8PRO3	CVR16PRO3	CVR32PRO3
Product Image			
Main Processor	Embedded Processor		
Operating System	Embedded Linux OS		
Video Input	8 channel BNC	16 channel BNC	32 channel BNC
Camera Configurations	Coaxial: 8 channels up to 8.0MP/7fps (HDCVI), 960H/25fps (analogue)	Coaxial: 16 channels up to 8.0MP/7fps (HDCVI), 960H/25fps (analogue)	Coaxial: 32 channels up to 1080p/15fps (HDCVI), 960H/25fps (analogue)
	Network: Add 4 channels up to 8.0MP Max 48Mbps Incoming Bandwidth	Network: Add 8 channels up to 8.0MP Max 96Mbps Incoming Bandwidth	Network: Add 32 channels up to 8.0MP Max 128Mbps Incoming Bandwidth
Audio In/Out	1 / 1		
Two-way Talk	Reuse channel 1 audio input/ output		1 channel input / output BNC
Video Output	1 HDMI / 1 VGA		
Display Resolution	3840 x 2160 to 1024 x 768	3840 x 2160 to 1280 x 720	1920 x 1080 to 1024 x 768
Display Split	1 / 4 / 8 / 9 / 16	1 / 4 / 8 / 9 / 16 / 25	1 / 4 / 8 / 9 / 16 / 25 / 36
OSD	Camera title, time, video loss, camera lock, MD & recording		
Maximum Resolution	8.0MP (3840 x 2160) / 4.0MP (2560 x 1440) / 1080p (1920 x 1080)		1080p (1920 x 1080) / 720p (1280 x 720)
Frame Rate	Main: 8.0MP (1~7fps) / 6.0MP (1~10fps) / 5.0MP (1~12fps) / 4.0MP & 3.0MP (1~15fps) / 1080p (1~25fps) / Sub: D1 (1~25fps)		Main: 1080p (1~15fps), 720p (1~25fps) Sub: D1 (1~15fps)
Video Compression	H.265+ / H.265 / H.264+ / H.264		
Bit Rate	1Kbps ~ 6144Kbps Per Channel	32Kbps ~ 6144Kbps Per Channel	
Record Modes	Manual / Schedule (Regular, Continuous) , Motion Detection , Alarm, Stop		
Record Interval	1 ~ 60 min (default: 60 min) / Pre: 1 ~ 30s / Post: 10 ~ 300s		
Alarm Input / Output	N/A		16 channel input / 6 relay output
Trigger Events	Recording: PTZ; tour; push video notification; email notification; FTP upload; snapshot; internal buzzer; and screen tip overlay		
Video Detection	MD zones: 396 (22 x 18) / Video Loss / Camera Blank		
Playback Sync	1 / 4 / 9	1 / 4 / 9 / 16	
Search Modes	Time/Date; Alarm, Motion detection; Exact search (to the second)		
Intelligent Functions	Face Detection, Tripwire, Abandoned/Missing Object		
Backup Modes	USB Device / Internal SATA burner / Network		USB Device / eSATA Device / Internal SATA burner (optional) / Network
Ethernet	1x RJ-45 port (1000M)		2x RJ-45 port (10/100M/1000M)
Network Functions	HTTP, IPv4/IPv6, TCP/IP, UPnP, RTSP, UDP, SMTP, NTP, DHCP, DNS, PPPoE, DDNS, FTP, IP Filter, SNMP, P2P	HTTP, HTTPS, TCP/IP, IPv4/IPv6, Wi-Fi, 3G/4G, UPnP, RTSP, UDP, SMTP, NTP, DHCP, DNS, IP Filter, PPPoE, DDNS, FTP, Alarm Server, P2P, IP Search	
Max. User Access	128 Users		
Remote View	IOS (iPhone, iPad); Android devices		
Internal HDD	2 SATA Ports, up to 20TB total		8 SATA Ports, up to 80TB total
USB Interface	2 ports: 1x USB2.0, 1x USB3.0		4 ports: 2x USB2.0, 2x USB3.0
Auxiliary Inputs	1 x RS485 Port (for PTZ)		1 x RS232 port (PC comm. & keyboard) / 1 x RS485 / 1 x RS422 port (PTZ control)
Power Supply	12VDC/4A	12VDC/5A	100 ~ 240VAC, 50/60 Hz
Power Consumption	<15W (without HDD)	<20W (without HDD)	<35W (without HDD)
Operating Environment	-10 ~ 55°C / 10 ~ 90%RH / 86 ~ 106kpa		
Dimensions	375mm x 287mm x 53mm		440mm x 455mm x 95mm (2U)
Weight	2.35kg (without HDD)		7.0kg (without HDD)

Accessories

Product Diagram

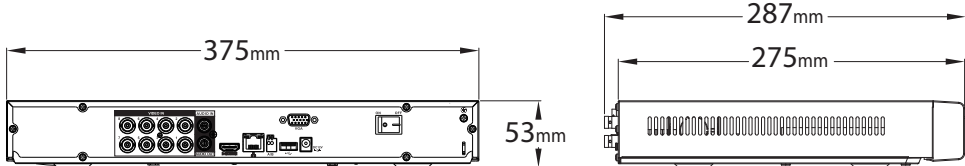
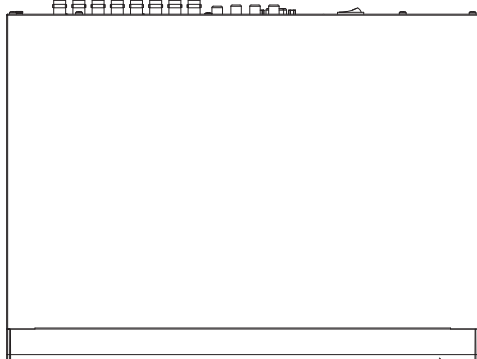
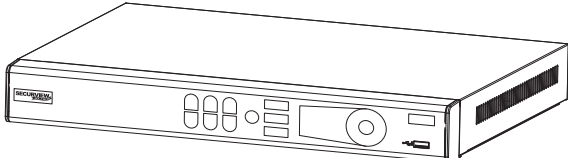
Above: CVR8PRO3

**AI**  
ARTIFICIAL INTELLIGENCE



# AI-enhanced CCTV upgrades.

Professional Series: Intelligent AI HDCVI DVRs available in 8 and 16 channels

Rapidly transform low-resolution surveillance into high performing HD CCTV, with support for IP & analogue video inputs. The Securview™ Professional AI Series offers advanced technologies to transform the way surveillance works for you. Monitor your operations using intelligent face recognition & AI people and vehicle detection. Identify strangers, set up blacklists, search playback by face and receive people & vehicle surveillance alerts to your devices.

- Record up to 8.0MP (3840 x 2160) at 7fps (HDCVI)
- Add additional IP channels up to 8.0MP resolution
- Up to 128Mbps incoming bandwidth, H.265+ support
- HDD support for up to 20TB footage storage
- HDMI (up to UHD/4K) & VGA simultaneous video output
- AI detection to identify people & vehicles with smart motion detection (SMD+) & perimeter protection
- Identify people for security & business intelligence with up to 2 channels of face recognition (with analogue cameras)
- Receive face recognition & people / vehicle detection alerts



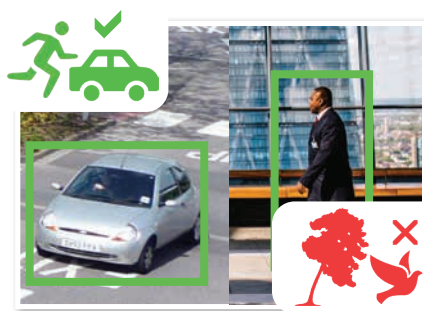

**AI Powered Facial Recognition**

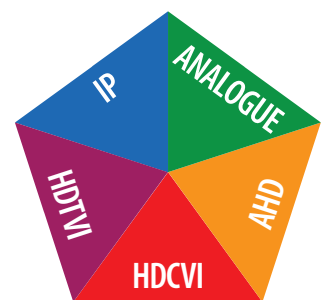

**Smart Person & Vehicle Detection**

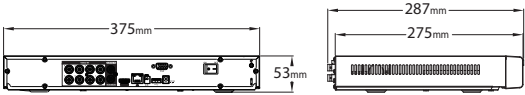
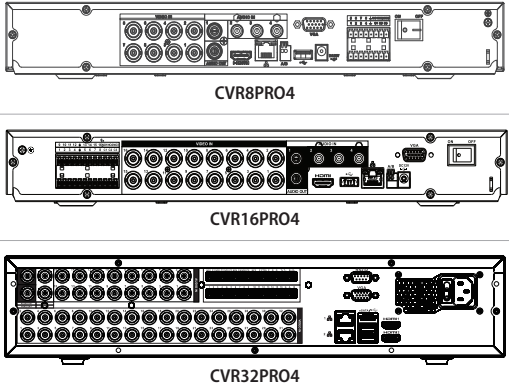

**Victory Synergy Compatibility**

Model	CVR8PRO4		CVR16PRO4		CVR32PRO4	
Product Image						
Main Processor / OS	Embedded Processor, embedded Linux OS					
Video Input	8 channel BNC		16 channel BNC		32 channel BNC	
Camera Configurations	Coaxial: 8 channels up to 8.0MP/7fps (HDCVI), 960H/25fps (analogue) Network: Add 8 channels up to 8.0MP Max 128Mbps Incoming Bandwidth		Coaxial: 16 channels up to 8.0MP/7fps (HDCVI), 960H/25fps (analogue) Network: Add 16 channels up to 8.0MP Max 128Mbps Incoming Bandwidth		Coaxial: 32 channels up to 8.0MP/7fps (HDCVI), 960H/25fps (analogue) Network: Add 32 channels up to 12.0MP Max 128Mbps Incoming Bandwidth	
Audio In/Out	4 / 1, RCA		4 / 1, RCA		16 / 1, BNC	
Two-way Talk	Reuse channel 1 audio input/output, RCA		Reuse channel 1 audio input/output, RCA		1 audio input/output, BNC	
Video Output	1 HDMI / 1 VGA		1 HDMI / 1 VGA		2 HDMI / 1 VGA / 1 TV	
Display Resolution	3840 x 2160 to 1280 x 720					
Display Split	1 / 4 / 8 / 9 (16 w/ IP extension mode enabled)		1 / 4 / 8 / 9 / 16 (25 / 32 w/ IP extension mode enabled)		1 / 4 / 8 / 9 / 16 / 25 / 32	
OSD	Camera title, time, video loss, camera lock, MD & recording					
Maximum Resolution	8.0MP (3840 x 2160) / 4.0MP (2560 x 1440) / 1080p (1920 x 1080)					
Frame Rate	Main: 8.0MP (1~7fps) / 6.0MP (1~10fps) / 5.0MP (1~12fps) / 4.0MP & 3.0MP (1~15fps) / 1080p (1~25fps) / Sub: 960H (1~15fps) / D1 (1~25fps)					
Video Compression	AI Coding / H.265+ / H.265 / H.264+ / H.264					
Bit Rate	32Kbps ~ 6144Kbps Per Channel					
Record Modes	Manual / Schedule (Regular, Continuous), Motion Detection (Video Detection, Motion Detection, Video Loss, Tampering), Alarm, Stop					
Record Interval	1 ~ 60 min (default: 60 min) / Pre: 1 ~ 30s / Post: 10 ~ 300s					
Performance (Faces)	Max. 12 face pictures per second (modeling and comparing) (Performance varies depending on camera and resolution)					
Performance (Channel)	Approx. 2 channels face recognition (Analogue cameras only)		Approx. 2 channels face recognition (Analogue cameras only)		Approx. 6 channels face recognition (Analogue cameras only)	
Stranger Mode	Detect strangers face (not in database)					
AI Search	Up to 8 target face images at the same time					
Database Management	Up to 10 face databases with 20,000 face images in total. Name, gender, birthday, nationality, address, ID information can be added to each face picture					
Database Application	Each database can be applied to video channels independently					
Trigger Events	Buzzer, Voice Prompts, Email, snapshot, Recording, Alarm Out, PTZ activation, etc					
Perimeter Protection	2 channels, 10 IVS rules for each channel		2 channels, 10 IVS rules for each channel		6 channels, 10 IVS rules for each channel	
Smart Motion Detection	8 channels		16 channels		32 channels	
Metadata	N/A					
AI Search	Search footage by target classification (Human, Vehicle)					
Object Classification	Perimeter Protection: Human / vehicle secondary recognition for tripwire / intrusion					
Alarm Input / Output	8 channel input / 3 relay output		16 channel input / 3 relay output		16 channel input / 6 relay output	
Trigger Events	Recording: PTZ; tour; push video notification; email notification; FTP upload; snapshot; internal buzzer; and screen tip overlay					
Video Detection	MD zones: 396 (22 x 18) / Video Loss / Tampering / Diagnosis					
Playback Sync	1 / 4 / 9		1 / 4 / 9		1 / 4 / 9 / 16	
Search Modes	Time/Date; Alarm, Motion detection; Exact search (to the second)					
Backup Modes	USB Device / Network					
Ethernet	1 x RJ-45 port (1000M)		1 x RJ-45 port (1000M)		2 x RJ-45 port (1000M)	
Network Functions	HTTP, HTTPS, IPv4/IPv6, TCP/IP, Wi-Fi, 3G/4G, SNMP, UPNP, RTSP, UDP, SMTP, NTP, DHCP, DNS, PPPOE, DDNS, FTP, IP Filter, Alarm Server, P2P, IP Search					
Max. User Access	128 Users					
Remote View	IOS (iPhone, iPad); Android devices					
Internal HDD	2 x SATA ports, up to 20TB total		2 x SATA ports, up to 20TB total		8 x SATA ports, up to 80TB total	
USB Interface	2 x ports: 1 x USB2.0, 1 x USB3.0		2 x ports: 1 x USB2.0, 1 x USB3.0		4 x ports: 2 x USB2.0, 2 x USB3.0	
Auxiliary Inputs	1 x RS485 port (for PTZ)		1 x RS485 port (for PTZ)		1 x RS485 port (for PTZ) / 1 x R232 port (for PC communication & keyboard)	
Power Supply	12VDC/4A		12VDC/5A		100~240VAC, 50/60Hz	
Power Consumption	<10W (without HDD)		<15W (without HDD)		<30W (without HDD)	
Operating Environment	-10 ~ 55°C / 10 ~ 90%RH					
Dimensions	375mm x 288mm x 53mm		375mm x 288mm x 53mm		440mm x 463mm x 95mm (2U)	
Weight	1.6kg (without HDD)		1.9kg (without HDD)		7.0kg (without HDD)	
Product Diagram						
	Above: CVR8PRO4					



# Ultimate Series HDCVI Surveillance Cameras

## Series Overview

Securview™ Ultimate Series motorised lens HDCVI cameras offer superior surveillance for CCTV upgrade installations with industry leading performance in resolution, image quality, low light capabilities and camera functionality.

Cameras are designed for replacing existing analogue coaxial surveillance systems, featuring a suite of options to make upgrading a breeze. 12VDC/24VAC input support, HD/SD dual video out and on-camera adjustments for easy integration with a variety of DVR technologies.

## Model Reference

SKU	Description
VSCVI2MPFBIRM100M	2.0MP Ultimate Motorised Bullet
VSCVI8MPFBIRM	8.0MP Ultimate Motorised Bullet
VSCVI2MPVDIRM50M	2.0MP Ultimate Motorised Dome
VSCVI8MPVDIRM	8.0MP Ultimate Motorised Dome



### Stream up to Ultra HD

Capture footage at 4K / Ultra HD with up to 3840 x 2160 resolution.



### Excellent in Low Light

With low light colour (1080p models), True WDR & auto white balance.



### Long Range Infrared

Record objects from up to 100m away at night with smart infrared technology.



### Easy Image Adjustment

Motorised lens auto-focuses while zooming, delivering more precise viewing angles.



### Compact & Resistant Body

Built with IP67 weather resistant housing, ideal for both indoor and outdoor use.



### Analogue Support

Compatible with analogue & HDCVI DVRs with dual/switchable BNC connectors.



## Series Highlights

### The best in image performance with motorised varifocal lens with auto iris

Ultimate Series cameras from Securview feature the most sophisticated optics and image processing technology to achieve excellent detail, even in challenging lighting conditions.

- Remote adjust field of view with motorised lens
- Lens iris automatically adjusts to incoming light for optimal image results in changing lighting



### Rapid & reliable installation with on-camera adjustment

Save time in camera installation & get the right image every time with on-camera settings found only in the Ultimate Series:

- On-camera motorised varifocal lens zoom and focus adjustments
- Dual BNC for HDCVI / Analogue output



### Superb low light performance with ultra low light colour illumination

Capture colour footage even in low ambient light with Ultra Low Light cameras in the Professional Series. Preserve forensic details that can prove critical in creating usable video evidence.

- Minimum colour illumination at as low as 0.005lx
- TrueWDR (120dB) for scenes with challenging lighting

### Incredible camera functionality with a suite of I/O functions & camera features

Ultimate Series models deliver the most functions of any HD coaxial camera. Integrate alarm sensors/triggers, add audio capture & output devices, use indoors or out and customise power input.

- Audio and alarm I/O to augment CCTV use
- Full metal IP67 weather & IK10 vandal rated body
- Dual voltage support for 12VDC or 24VAC input





# Long range performance.

Ultimate Series: Motorised lens HDCVI bullets available in 2.0MP & 8.0MP

Experience unparalleled performance with the Ultimate Series from Securview, with image performance up to 8.0MP/Ultra HD, auto-iris motorised lens, dual voltage support, true WDR and audio/alarm interface.

- Stream up to 8.0MP/UHD/4K (3840 x 2160)
- Motorised varifocal lens with auto-iris (DC)
- Smart infrared illumination, up to 100m range
- Up to 700m 8.0MP video transmission over coaxial cable (performed under ideal test conditions)
- Colour image in low light at 0.005lx (2.0MP only)
- Dual BNC outputs for HD and composite video
- Dual voltage compatible: 12VDC and 24VAC
- True WDR (120dB) and 2D/3D noise reduction
- IP67, metal weather rated camera housing



Stream Ultra HD Over Coax



Superb Low Light Performance



Dual Voltage Compatible

Model	VSCVI2MPFBIRM100M	VSCVI8MPFBIRM	
<b>Image Sensor</b>	1/2.8" 2.1 Megapixel CMOS	1/2" 8.0 Megapixel CMOS	
<b>Effective Pixels</b>	1945 (H) x 1097 (V)	3840 (H) x 2160 (V)	
<b>Signal Noise Ratio</b>	> 50dB	> 65dB	
<b>Lens</b>	2.7 ~ 12mm F1.4 Motorised Lens; Auto Iris	3.7 ~ 11mm F1.5 Motorised Lens; Auto Iris	
<b>Angle of View</b>	95° (wide) ~ 36° (tele)	112° (wide) ~ 46° (tele)	
<b>Focus</b>	Auto/Manual Focus / 0.3m Min. Focus Distance	Auto/Manual Focus / 0.2m Min. Focus Distance	
<b>Minimum Illumination</b>	0.005 Lux at F1.4 (Colour) / 0 Lux IR Active	0.01 Lux at F1.5 (Colour) / 0 Lux IR Active	
<b>Electronic Shutter</b>	1/3 ~ 1/30,000s	1/3 ~ 1/100,000s	
<b>Day/Night</b>	Auto (ICR) / Colour / B&W		
<b>Infrared Range</b>	100m		
<b>White Balance</b>	Auto		
<b>Noise Reduction</b>	2D / 3D		
<b>Gain Control</b>	Auto		
<b>Lighting Compensation</b>	BLC / WDR (120dB)		
<b>Resolution</b>	1080p (1920 x 1080) to CIF (352 x 288)	8.0MP (3840 x 2160) to CIF (352 x 288)	
<b>Frame Rate</b>	25fps (1080p and lower)	12fps (8.0MP) / 25fps (4.0MP and lower)	
<b>Transmission Distance</b>	Rated for up to 700m via 75-3 coaxial cable (performed in ideal test conditions)		
<b>DORI</b>	<b>Detect</b>	48m (wide) / 133m (tele)	83m (wide) / 190m (tele)
	<b>Observe</b>	19m (wide) / 53m (tele)	33m (wide) / 76m (tele)
	<b>Recognise</b>	10m (wide) / 27m (tele)	17m (wide) / 38m (tele)
	<b>Identify</b>	5m (wide) / 13m (tele)	8 (wide) / 19m (tele)
<b>Audio Input</b>	1 channel in		
<b>Alarm Interface</b>	1 channel in / 1 channel out	2 channel in / 1 channel out	
<b>Video Output</b>	2 x BNC video output (1 x HDCVI / 1 x Composite SD)		
<b>Synchronisation</b>	Internal		
<b>OSD Menu</b>	Support		
<b>Ingress Protection</b>	IP67		
<b>Vandal Resistant</b>	N/A		
<b>Housing</b>	Metal		
<b>Power Input</b>	12VDC / 24VAC		
<b>Power Consumption</b>	< 16.6W	< 18.4W	
<b>Dimensions</b>	273 x 95 x 95mm		
<b>Weight</b>	1.20kg	1.08kg	
<b>Operating Environment</b>	-30° to 60°C / RH95% (max)		
<b>Diagram</b>			
<b>Accessories</b>			
<b>Models</b>	Junction Box (VSBKTA121)	Pole Mount (VSBKTA121 + VSBKTA152)	Corner Mount (VSBKTA121 + VSBKTA151)



# Ultra high definition HDCVI.

Ultimate Series: Motorised lens HDCVI domes available in 2.0MP & 8.0MP

Experience unparalleled performance with the Ultimate Series from Securview, with image performance up to 8.0MP/Ultra HD, auto-iris motorised lens, dual voltage support, true WDR and audio/alarm interface.

- Stream up to 8.0MP/UHD/4K (3840 x 2160)
- Motorised varifocal lens with auto-iris (DC)
- Smart infrared illumination, up to 100m range
- Up to 700m 8.0MP video transmission over coaxial cable (performed under ideal test conditions)
- Colour image in low light at 0.005lx (2.0MP only)
- Dual BNC outputs for HD and composite video
- Dual voltage compatible: 12VDC and 24VAC
- True WDR (120dB) and 2D/3D noise reduction
- IP67/IK10, metal weather rated camera housing



**Stream Ultra HD Over Coax**



**Superb Low Light Performance**



**Dual Voltage Compatible**

Model		VSCVI2MPVDIRM50M	VSCVI8MPVDIRM				
Camera	Image Sensor	1/2.8" 2.1 Megapixel CMOS	1/2" 8.0 Megapixel CMOS				
	Effective Pixels	1945 (H) x 1097 (V)	3840 (H) x 2160 (V)				
	Signal Noise Ratio	> 50dB	> 65dB				
	Lens	2.7 ~ 12mm F1.4 Motorised Lens; Auto Iris	3.7 ~ 11mm F1.5 Motorised Lens; Auto Iris				
	Angle of View	95° (wide) ~ 36° (tele)	112° (wide) ~ 46° (tele)				
	Focus	Auto/Manual / 0.3m Min. Focus Distance	Auto/Manual Focus / 0.2m Min. Focus Distance				
	Minimum Illumination	0.005 Lux at F1.4 (Colour) / 0 Lux IR Active	0.01 Lux at F1.5 (Colour) / 0 Lux IR Active				
	Electronic Shutter	1/3 ~ 1/30,000s	1/3 ~ 1/100,000s				
	Day/Night	Auto (ICR) / Colour / B&W					
	Infrared Range	50m					
	White Balance	Auto					
	Noise Reduction	2D / 3D					
	Gain Control	Auto					
	Lighting Compensation	BLC / HLC / WDR (120dB)					
Video	Resolution	2.0MP (1920 x 1080) to CIF (352 x 288)	8.0MP (3840 x 2160) to CIF (352 x 288)				
	Frame Rate	25fps (1080p and lower)	12fps (8.0MP) / 25fps (4.0MP and lower)				
	Transmission Distance	Rated for up to 700m via 75-3 coaxial cable (performed in ideal test conditions)					
DORI	Distance	Detect	48m (wide) / 133m (tele)				
		Observe	19m (wide) / 53m (tele)				
		Recognise	10m (wide) / 27m (tele)				
		Identify	5m (wide) / 13m (tele)				
Interface	Audio Input	1 channel in					
	Alarm Interface	1 channel in / 1 channel out	2 channel in / 1 channel out				
	Video Output	2 x BNC video output (1 x HDCVI / 1 x Composite SD)					
	Synchronisation	Internal					
Environmental	OSD Menu	Support					
	Ingress Protection	IP67					
	Vandal Resistant	IK10					
	Housing	Metal, Polycarbonate					
	Power Input	12VDC / 24VAC					
	Power Consumption	< 12.5W	< 12.4W				
	Dimensions	Ø159 x 118mm					
	Weight	0.90kg					
Operating Environment	-30° to 60°C / RH95% (max)						
Accessories	Diagrams						
	Accessories						
Models	Junction Box (VSBKTA138)	In-Ceiling Mount (VSBKTB201C)	Wall Mount Rain Shield (VSBKTB210W)	Ceiling Extension (VSBKTB300C + VSBKTA101)	Right Angle Wall Mount (VSBKTB302S + VSBKTA101)	Pole Mount (VSBKTB302S + VSBKTA152 + VSBKTA101)	Corner Mount (VSBKTB302S + VSBKTA151 + VSBKTA101)



# Professional Series

## Motorised lens HDCVI cameras

### Series Overview

Securview™ Professional Series motorised lens HDCVI bullet and dome cameras are perfect for mid to large surveillance solutions.

Adjust for multiple viewing angles with remote zooming to achieve the perfect image every time.

Professional series HDCVI cameras are built for both HDCVI and Analogue recorders, allowing flexibility in your CCTV upgrades.

### Model Reference

SKU	Description
VSCVI2MPFBIRMV4	2.0MP Motorised Bullet
VSCVI-5BIRMG	5.0MP Motorised Bullet
VSCVI-8BIRMG	8.0MP Motorised Bullet
VSCVI-5DIRMG	5.0MP Motorised Turret Dome
VSCVI-8DIRMG	8.0MP Motorised Turret Dome
VSCVI2MPVDIRMV4	2.0MP Motorised Vandal Dome
VSCVI-5DIRMD	5.0MP Motorised Vandal Dome



#### Stream up to Ultra HD

Capture footage at 4K / Ultra HD with up to 3840 x 2160 resolution.



#### Excellent in Low Light

With low light colour (select models), True WDR & auto white balance.



#### Long Range Infrared

Record objects from up to 80m away at night with smart infrared technology.



#### Easy Image Adjustment

Remotely adjust field of view to get perfect images with motorised varifocal lenses.



#### Compact & Resistant Body

Built with IP67 weather resistant housing, ideal for both indoor and outdoor use.

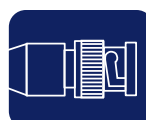

#### Backwards Compatibility

Select video output modes via DIP switch, in analogue, HDTVI, AHD or HDCVI.

## Series Highlights

### Always get the perfect image with remote field of view adjustment

Every camera in this series feature a motorised varifocal lens, enabling remote focal length adjustment to get the desired field of view every time.

- Configure for wide or narrow field of view
- Maximise usable footage, eg: avoid walls, fences
- Easy installation - mount now, adjust zoom later
- Configure zoom remotely via PC, phone or tablet



### Backwards compatibility with switchable video output

Each Professional Series camera features backwards compatibility support for a variety of transmission technologies:

- HDCVI / TVI / AHD / Analogue via camera DIP switches or via UTC controller
- Dual BNC for HDCVI / Analogue output



### Superb low light performance with ultra low light colour illumination

Capture colour footage even in low ambient light with Ultra Low Light cameras in the Professional Series. Preserve forensic details that can prove critical in creating usable video evidence.

- Minimum colour illumination at as low as 0.005lx
- True WDR (120dB) for scenes with challenging lighting

### All purpose HDCVI surveillance with full metal, weather rated camera chassis

Professional Series cameras offer excellent weather resistance and are perfect for almost all indoor and outdoor applications.

- IP67 rated: Dust-tight / water-ingress resistant camera bodies for use in all environments
- Full powder-coated aluminium chassis
- Marine grade models available





# Superb image performance.

Professional Series: Motorised lens HDCVI bullets in 2.0MP, 5.0MP & 8.0MP

With superior 80m infrared illumination, 4K resolution and ultra low light colour, the G-Body series from Securview captures clear footage at all hours, featuring a motorised varifocal lens for easy remote image adjustment.

- Stream up to UHD/4K/8.0MP (3840 x 2160) at 15fps
- Motorised varifocal lens with fixed iris
- Large 1/2" sensor for excellent low light performance
- Smart infrared illumination, up to 80m range
- HDCVI / AHD / TVI / Analog switchable (DIP switch)
- Up to 700m video transmission over coaxial cable
- True WDR (120dB) and 2D/3D noise reduction
- IP67 rated weather resistant metal housing



Ultra HD Recording Over Coax



DVR Cross Compatibility



Superb Low Light Performance



Model	VSCVI2MPFBIRMV4	VSCVI-5BIRMG	VSCVI-8BIRMG	
Image Sensor	1/2.8" 2.0 Megapixel CMOS	1/2.8" 5.0 Megapixel CMOS	1/2" 8.0 Megapixel CMOS	
Effective Pixels	1920 (H) x 1080 (V)	2592 (H) x 1944 (V)	3840 (H) x 2160 (V)	
Signal Noise Ratio	> 65dB			
Lens	2.7mm ~ 13.5mm F1.6 Motorised Lens, fixed iris	2.7mm ~ 13.5mm F1.3 Motorised Lens, fixed iris	3.7mm ~ 11mm F1.5 Motorised Lens, fixed iris	
Angle of View	109° (wide) ~ 29° (tele)	102° (wide) ~ 29° (tele)	112° (wide) ~ 46° (tele)	
Focus	Fixed / 0.2m Min. Focus Distance	Fixed / 0.2m Min. Focus Distance	Fixed / 1.8m Min. Focus Distance	
Minimum Illumination	0.004 Lux at F1.6 (Colour) / 0 Lux IR Active	0.005 Lux at F1.3 (Colour) / 0 Lux IR Active	0.005 Lux at F1.5 (Colour) / 0 Lux IR Active	
Electronic Shutter	1/4 ~ 1/100,000s			
Day/Night	Auto (ICR) / Colour / B&W			
Infrared Range	80m			
White Balance	Auto / Manual			
Noise Reduction	2D / 3D			
Gain Control	Auto			
Lighting Compensation	BLC / HLC / WDR (120dB)			
Resolution	1080p (1920 x 1080) to CIF (352 x 288)	5.0MP (2592 x 1944) to CIF (352 x 288)	8.0MP (3840 x 2160) to CIF (352 x 288)	
Frame Rate	25fps (1080p and lower)	20fps (5.0MP) / 25fps (4.0MP and lower)	15fps (8.0MP) / 20fps (6.0MP) / 25fps (4.0MP and lower)	
Transmission Distance	Rated for up to 700m via 75-3 coaxial cable (performed in ideal test conditions)			
DORI	Detect	44m (wide) / 153m (tele)	64m (wide) / 222m (tele)	83m (wide) / 190m (tele)
	Observe	18m (wide) / 61m (tele)	26m (wide) / 89m (tele)	33m (wide) / 76m (tele)
	Recognise	9m (wide) / 31m (tele)	13m (wide) / 44m (tele)	17m (wide) / 38m (tele)
	Identify	4m (wide) / 15m (tele)	6m (wide) / 22m (tele)	8m (wide) / 19m (tele)
Audio Input	Built-in Microphone / 1 Input			
Alarm Interface	N/A			
Video Output	1 x HDCVI / AHD / TVI / Composite Video Output (DIP switch)			
Synchronisation	Internal			
OSD Menu	Support			
Ingress Protection	IP67			
Vandal Resistant	N/A			
Housing	Aluminium			
Power Input	12VDC / 24VAC	12VDC / 24VAC	12VDC	
Power Consumption	< 11.1W	< 17.2W	< 12.5W	
Dimensions	244 x 90 x 90mm			
Weight	0.81kg	0.81kg	0.76kg	
Operating Environment	-30° to 60°C / RH90% (max)			
Diagram				
Accessories				
Accessories	<p>Refer to bracket compatibility guide for complete list</p>			
Models	Junction Box (VSBKTA130E)	Pole Mount (VSBKTA130E + VSBKTA152E)	Corner Mount (VSBKTA130E + VSBKTA151)	



# Impressive 4K over coax.

Professional Series: Motorised lens HDCVI dome available in 5.0MP & 8.0MP

High resolution image quality up to 4K and a compact, weather resistant aluminium body. This series captures excellent video footage with long range infrared, True WDR and zero image distortion with its flat glass lens cover.

- Stream up to UHD/4K/8.0MP (3840 x 2160) at 15fps
- Motorised varifocal lens with fixed iris
- Large 1/2" sensor for excellent low light performance
- Smart infrared illumination, up to 60m range
- HDCVI / AHD / TVI / Analog switchable (DIP switch)
- Up to 700m video transmission over coaxial cable
- True WDR (120dB) and 2D/3D noise reduction
- IP67 rated weather resistant metal housing



**Ultra HD Recording Over Coax**



**DVR Cross Compatibility**



**Superb Low Light Performance**

Model		VSCVI-5DIRMG	VSCVI-8DIRMG	
Camera	Image Sensor	1/2.8" 5.0 Megapixel CMOS	1/2" 8.0 Megapixel CMOS	
	Effective Pixels	2592 (H) x 1944 (V)	3840 (H) x 2160 (V)	
	Signal Noise Ratio	> 65dB		
	Lens	2.7mm ~ 13.5mm F1.3 Motorised Lens, fixed iris	3.7mm ~ 11mm F1.5 Motorised Lens, fixed iris	
	Angle of View	102° (wide) ~ 29° (tele)	112° (wide) ~ 46° (tele)	
	Focus	Fixed / 0.2m Min. Focus Distance	Fixed / 1.8m Min. Focus Distance	
	Minimum Illumination	0.005 Lux at F1.3 (Colour) / 0 Lux IR Active	0.005 Lux at F1.5 (Colour) / 0 Lux IR Active	
	Electronic Shutter	1/4s ~ 1/100,000s		
	Day/Night	Auto (ICR) / Colour / B&W		
	Infrared Range	60m		
	White Balance	Auto / Manual		
	Noise Reduction	2D / 3D		
	Gain Control	Auto		
	Lighting Compensation	BLC / HLC / WDR (120dB)		
Video	Resolution	5.0MP (2592 x 1944) to CIF (352 x 288)	8.0MP (3840 x 2160) to CIF (352 x 288)	
	Frame Rate	20fps (5.0MP) / 25fps (4.0MP and lower)	15fps (8.0MP) / 20fps (6.0MP) / 25fps (4.0MP and lower)	
	Transmission Distance	Rated for up to 700m via 75-3 coaxial cable (performed in ideal test conditions)		
DORI	Distance	Detect	64m (wide) / 222m (tele)	
		Observe	26m (wide) / 89m (tele)	
		Recognise	13m (wide) / 44m (tele)	
		Identify	6m (wide) / 22m (tele)	
Interface	Audio Input	Built-in Microphone / 1 Input		
	Alarm Interface	N/A		
	Video Output	1 x HDCVI / AHD / TVI / Composite Video Output (DIP switch)		
	Synchronisation	Internal		
	OSD Menu	Support		
Environmental	Ingress Protection	IP67		
	Vandal Resistant	N/A		
	Housing	Aluminium		
	Power Input	12VDC / 24VAC	12VDC	
	Power Consumption	< 14.1W	< 9.5W	
	Dimensions	Ø122mm x 107mm		
	Weight	0.64kg	0.59kg	
Operating Environment	-30° to 60°C / RH90% (max)			
Accessories	Diagram			
	Accessories			
Models	Junction Box (VSBKTA130E)	Wall Mount (VSBKTB203W)	Pole Mount (VSBKTA130E + VSBKTA152E)	Corner Mount (VSBKTA130E + VSBKTA151)



# Excels in all applications.

Professional Series: Motorised lens HDCVI domes available in 2.0MP & 5.0MP

A excellent camera in all conditions with a wide range of compatible brackets, Professional Series domes from Securview offer up to 9x analogue resolution & easy adjustments via a motorised lens, all in a durable housing.

- Stream up to 5.0MP (2592 x 1944) at 20fps
- 2.7~13.5mm motorised varifocal lens with fixed iris
- Up to 700m video transmission over coaxial cable
- Smart infrared illumination, up to 30m range
- Superb low light colour images as low as 0.005lx
- True WDR (120dB) and 2D/3D noise reduction
- Dual voltage compatible: 12VDC and 24VAC
- IP67/IK10 for weather and vandal resistance

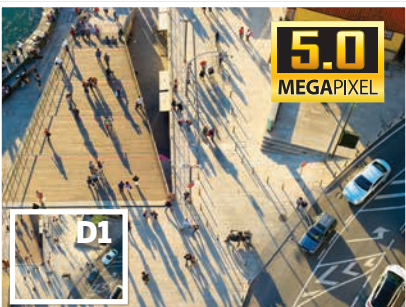

Up to 12x Image Resolution vs D1



Superb Low Light Performance



Dual Voltage Compatible

Model		VSCVI2MPVDIRMV4	VSCVI-5DIRMD				
Camera	Image Sensor	1/2.8" 2.1 Megapixel CMOS	1/2.8" 5.0 Megapixel CMOS				
	Effective Pixels	1920(H) x 1080(V)	2592 (H) x 1944 (V)				
	Signal Noise Ratio	> 65dB					
	Lens	2.7 ~ 13.5mm F1.6 Motorised Lens; Fixed Iris					
	Angle of View	2.7 ~ 13.5mm F1.3 Motorised Lens; Fixed Iris					
	Focus	109° (wide) ~ 29° (tele)					
	Focus	Auto/Manual / 0.2m Min. Focus Distance					
	Minimum Illumination	0.004Lux/F1.6, 30IRE, 0Lux IR Active	0.005 Lux at F1.3 (Colour) / 0 Lux IR Active				
	Electronic Shutter	1/4 ~ 1/100,000s					
	Day/Night	Auto (ICR) / Manual					
Infrared Range	30m						
White Balance	Auto / Manual						
Noise Reduction	2D / 3D						
Gain Control	Auto						
Lighting Compensation	BLC / HLC / WDR (120dB)						
Video	Resolution	1080p (1920 x 1080) to CIF (352 x 288)	5.0MP (2592 x 1944) to CIF (352 x 288)				
	Frame Rate	25fps (1080p and lower)	20fps (5.0MP), 25fps (4.0MP and lower)				
	Transmission Distance	Rated for up to 700m via 75-3 coaxial cable (performed in ideal test conditions)					
DORI	Distance	Detect	44m (wide) / 153m (tele)				
		Observe	18m (wide) / 61m (tele)				
		Recognise	9m (wide) / 31m (tele)				
		Identify	5m (wide) / 15m (tele)				
Interface	Audio Input	N/A	1 channel in				
	Alarm Interface	N/A					
	Video Output	1 x HDCVI / AHD / TVI / Composite Video Output (DIP switch)					
	Synchronisation	Internal					
	OSD Menu	Support					
Environmental	Ingress Protection	IP67					
	Vandal Resistant	IK10					
	Housing	Metal, Polycarbonate					
	Power Input	12VDC / 24VAC					
	Power Consumption	< 5.9W	< 11.8W				
	Dimensions	Ø122 x 89mm					
Weight	0.43kg	0.48kg					
Operating Environment	-30° to 60°C / RH90% (max)						
Accessories	Diagram						
Models	Junction Box (VSBKTA137)	In-Ceiling Mount (VSBKTB200C)	Wall Mount (VSBKTB203W)	Wall Mount Rain Shield (VSBKTA200W)	Ceiling Extension (VSBKTA106 + VSBKTB220C)	Right Angle Wall Mount (VSBKTA106 + VSBKTB305W)	Pole Mount (VSBKTA152 + VSBKTB203W)



# Professional Series

## Fixed lens HDCVI cameras

### Series Overview

Securview™ Professional Series fixed lens HDCVI cameras are built to effectively upgrade your existing standard analogue surveillance.

Achieve up to 20x analogue resolution by replacing cameras and the DVR, utilising existing coaxial cable. The series comes in a wide range of models to suit your exact application.

### Model Reference

SKU	Description
VSCVI-8BIRP	8.0MP Fixed Bullet w/ Dual Motion Det.
VSCVI-5BIR2.8E	5.0MP Fixed Bullet (2.8mm)
VSCVI-8BIRG	8.0MP Fixed Bullet
VSCVI-2DFCG	2.0MP Fixed Dome (Full Colour)
VSCVI-5DIR2.8G	5.0MP Fixed Dome (2.8mm)
VSCVI-8DIRG	8.0MP Fixed Dome
VSCVI-5DIR2.8D	5.0MP Fixed Dome (Vandal)



#### Stream up to Ultra HD

Capture footage at 4K / Ultra HD with up to 3840 x 2160 resolution.



#### Excellent in Low Light

With low light colour (select models), True WDR & auto white balance.



#### Long Range Infrared

Detect objects up to 50m at night with smart infrared technology.



#### Wide Dynamic Range

Preserve video evidence details in challenging light with True WDR across the range.



#### Compact & Resistant Body

Built with IP67 weather resistant housing, ideal for both indoor and outdoor use.

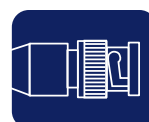

#### Backwards Compatibility

Video output modes via DIP switch (select models), in analogue, HDTVI, AHD & HDCVI.

## Series Highlights

### Versatile range to choose from with multiple fixed lens focal length options

Perfect for general purpose surveillance, fixed lens HDCVI cameras can cover narrow to wide focal ranges and are available in 6 different housing styles. Ideal for a variety of mount location, indoors and out.

- Available in 2.8mm and 3.6mm fixed lens, ranging from 80° to 110° wide horizontal field of view
- Compact turret or vandal dome, and bullet styles



### Backwards compatibility with switchable video output

Each Professional Series camera features backwards compatibility support for a variety of transmission technologies:

- HDCVI / TVI / AHD / Analogue via camera DIP switches or via UTC controller
- Dual BNC for HDCVI / Analogue output



### Superb low light performance with ultra low light colour illumination

Capture colour footage even in low ambient light with Ultra Low Light cameras in the Professional Series. Preserve forensic details that can prove critical in creating usable video evidence.

- Minimum colour illumination at as low as 0.005lx
- TrueWDR (120dB) for scenes with challenging lighting

### Improved intrusion detection with PIR motion detection technology

Better detect intruders with the Professional Series fixed bullet with built in passive-infrared (PIR) motion detection.

- Motion detection on heat-emitting objects
- Eliminate false triggers due to wind, trees, etc.
- Timestamp playback footage & trigger app notifications on PIR motion detection

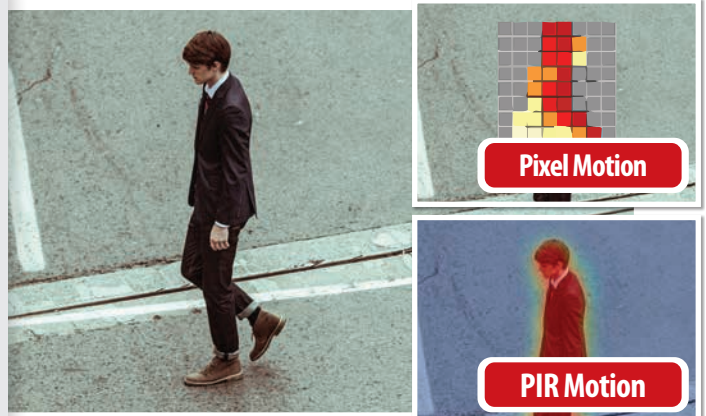



# Precise motion detection.

## Professional Series: Fixed lens 8.0MP HDCVI bullet with dual motion detection

Deliver accurate motion detection indoors and out. This fixed lens bullet combines in-camera pixel & passive-infrared motion detection, eliminating false alarms, activating only when both motion & heat are detected at the same time.

- Stream up to UHD/4K/8.0MP (3840 x 2160) at 15fps
- 2.8mm fixed lens with wide 110° viewing angle
- Pixel and passive-infrared motion detection
- Infrared illumination at up to 20m range
- HDCVI / AHD / TVI / Analog switchable via DIP switch
- Up to 700m video transmission over coaxial cable
- True WDR (120dB) and 2D/3D noise reduction
- IP67 rated weather resistance metal housing



**Ultra HD Recording Over Coax**



**DVR Cross Compatibility**

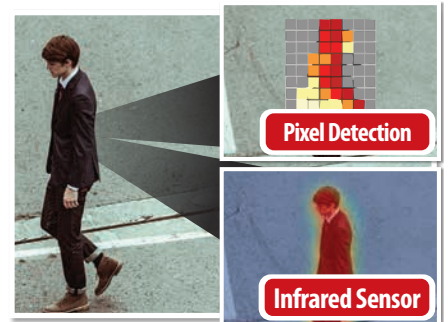

**Passive-Infrared Motion Detect**



	<b>Model</b>	<b>VSCVI-8BIRP</b>	
<b>Camera</b>	Image Sensor	1/2" 8.0 Megapixel CMOS	
	Effective Pixels	3840 (H) x 2160 (V)	
	Signal Noise Ratio	>65dB	
	Lens	2.8mm F1.6 Fixed Lens	
	Angle of View	111°	
	Focus	Fixed / 1.8m Min Focus Distance	
	Minimum Illumination	0.005 Lux at F1.6 (Colour) / 0 Lux IR Active	
	Electronic Shutter	1/4s ~ 1/100,000s	
	Day/Night	Auto (ICR) / Colour / B&W	
	Infrared Range	20m	
	White Balance	Auto / Manual	
	<b>Video</b>	Resolution	8.0MP (3840 x 2160) to CIF (352 x 288)
Frame Rate		15fps (8.0MP) / 20fps (6.0MP) / 25fps (4.0MP and lower)	
Transmission Distance		Rated for up to 700m via coaxial cable (performed in ideal test conditions)	
<b>DORI</b>	DORI Distance	Detect	84m
		Observe	34m
		Recognise	17m
		Identify	8m
<b>Interface</b>	Audio Input	N/A	
	Alarm Interface	N/A	
	Video Output	1 x HDCVI / AHD / TVI / Composite video output (switchable via DIP switch)	
	Synchronisation	Internal	
	OSD Menu	Support	
<b>Environmental</b>	Ingress Protection	IP67	
	Vandal Resistant	N/A	
	Housing	Aluminium (front cover) + Plastic (rear barrel)	
	Power Input	12VDC	
	Power Consumption	< 5.3W	
	Dimensions	147 x 72 x 83mm	
	Weight	0.25kg	
	Operating Environment	-10°C ~ +50°C/RH 95% (max)	
<b>Accessories</b>	<b>Diagram</b>		
	<b>Accessories</b>		
<b>Models</b>	Junction Box (VSBKTA134)	Pole Mount (VSBKTA134 + VSBKTA152E)	



# Small profile, high detail.

Professional Series: Fixed lens HDCVI mini bullets in 5.0MP & 8.0MP

Create installs that offer high performance surveillance over coax, all in a compact body. Deliver Ultra HD evidence in challenging conditions with weather resistance for outdoor use, low light colour footage and a small install footprint.

- Stream up to UHD/4K/8.0MP (3840 x 2160) at 15fps
- Available in 2.8mm fixed lens models
- Large 1/2" sensor for excellent low light performance
- Smart infrared illumination, up to 50m range
- HDCVI / AHD / TVI / Analog switchable via DIP switch
- Up to 700m video transmission over coaxial cable
- True WDR (120dB) and 2D/3D noise reduction
- IP67 rated weather resistance for outdoor use



**Ultra HD Recording Over Coax**



**DVR Cross Compatibility**



**Superb Low Light Performance**

Model		VSCVI-5BIRE	VSCVI-8BIRG	
Product Variants by Model		VSCVI-5BIR2.8E: 2.8mm Fixed Lens	VSCVI-8BIRG: 2.8mm Fixed Lens	
Image Sensor		1/2.8" 5.0 Megapixel CMOS	1/2" 8.0 Megapixel CMOS	
Effective Pixels		2592 (H) x 1944 (V)	3840 (H) x 2160 (V)	
Signal Noise Ratio		> 65dB		
Lens		2.8mm F1.6 Fixed Lens	2.8mm F1.6 Fixed Lens	
Angle of View		98°	111°	
Focus		Fixed / 0.8m Min. Focus Distance	Fixed / 1.8m Min. Focus Distance	
Minimum Illumination		0.005 Lux at F1.6 (Colour) / 0 Lux IR Active	0.005 Lux at F1.6 (Colour) / 0 Lux IR Active	
Electronic Shutter		1/4 ~ 1/100,000s		
Day/Night		Auto (ICR) / Colour / B&W		
Infrared Range		40m		
White Balance		Auto / Manual		
Noise Reduction		2D / 3D		
Gain Control		Auto		
Lighting Compensation		BLC / HLC / WDR (120dB)		
Resolution		5.0MP (2592 x 1944) to CIF (352 x 288)	8.0MP (3840 x 2160) to CIF (352 x 288)	
Frame Rate		20fps (5.0MP) / 25fps (4.0MP and lower)	15fps (8.0MP) / 20fps (6.0MP) / 25fps (4.0MP and lower)	
Transmission Distance		Rated for up to 700m via 75-3 coaxial cable (performed in ideal test conditions)		
DORI	DORI Distance	Detect	56m	84m
		Observe	22m	34m
		Recognise	11m	17m
		Identify	6m	8m
Audio Input		1 channel in & Built-in Mic		
Alarm Interface		N/A		
Video Output		1 x HDCVI / AHD / TVI / Composite video output (switchable via DIP switch)		
Synchronisation		Internal		
OSD Menu		Support		
Ingress Protection		IP67		
Vandal Resistant		N/A		
Housing		Aluminium		
Power Input		12VDC		
Power Consumption		< 7W	< 8W	
Dimensions		180 x 70 x 70mm		
Weight		0.42kg	0.50kg	
Operating Environment		-30°C to 60°C / RH90% (max)		
Accessories	Diagram			
	Accessories			
Models	Junction Box (VSBKTA121)	Pole Mount (VSBKTA150 + VSBKTA121)	Corner Mount (VSBKTA151 + VSBKTA121)	



# Amazing low light colour.

Professional Series: Fixed lens HDCVI mini domes in 2.0MP, 5.0MP & 8.0MP

Create installs that offer high performance surveillance over coax, all in a compact body. Deliver evidence in the most challenging conditions with weather resistance for outdoor use, low light colour footage and a small footprint.

- Stream up to UHD/4K/8.0MP (3840 x 2160) at 15fps
- 2.8mm/3.6mm fixed lens with 111° viewing angle
- Large 1/2" sensor for excellent low light performance
- Smart infrared illumination, up to 50m range
- Superb low light colour at 0.001lx (full colour model)
- True WDR (120dB) and 2D/3D noise reduction
- Up to 700m video transmission over coaxial cable
- HDCVI / AHD / TVI / Analog switchable via DIP switch
- IP67 rated weather resistance for outdoor use
- Compact Ø106mm installation footprint



**Ultra HD Recording Over Coax**



**DVR Cross Compatibility**



**Superb Low Light Performance**

Model	VSCVI-2DFCG	VSCVI-5DIRG	VSCVI-8DIRG
<b>Product Variants by Model</b>	VSCVI-2DFCG: 3.6mm, Full Colour	VSCVI-5DIR2.8G: 2.8mm Fixed Lens	VSCVI-8DIRG: 2.8mm Fixed Lens
<b>Image Sensor</b>	1/2.8" 2.0 Megapixel CMOS	1/2" 5.0 Megapixel CMOS	1/2" 8.0 Megapixel CMOS
<b>Effective Pixels</b>	1920 (H) x 1080 (V)	2592 (H) x 1944 (V)	3840 (H) x 2160 (V)
<b>Signal Noise Ratio</b>	> 65dB		
<b>Lens</b>	3.6mm F1.0 Fixed Lens	2.8mm F1.6 Fixed Lens	2.8mm F1.6 Fixed Lens
<b>Angle of View</b>	90°	98°	111°
<b>Focus</b>	Fixed / 1.6m Min. Focus Distance	Fixed / 0.8m Min. Focus Distance	Fixed / 1.8m Min. Focus Distance
<b>Minimum Illumination</b>	0.001 Lux at F1.0 (Colour)	0.005 Lux at F1.6 (Colour) / 0 Lux IR Active	0.005 Lux at F1.6 (Colour) / 0 Lux IR Active
<b>Electronic Shutter</b>	1/4 ~ 1/100,000s		
<b>Day/Night</b>	Auto (ICR) / Colour / B&W		
<b>Infrared Range</b>	N/A	50m	50m
<b>White Balance</b>	Auto / Manual		
<b>Noise Reduction</b>	2D / 3D		
<b>Gain Control</b>	Auto		
<b>Lighting Compensation</b>	BLC / HLC / WDR (120dB)		
<b>Resolution</b>	1080p (1920 x 1080) to CIF (352 x 288)	5.0MP (2592 x 1944) to CIF (352 x 288)	8.0MP (3840 x 2160) to CIF (352 x 288)
<b>Frame Rate</b>	25fps (1080p and lower)	20fps (5.0MP) / 25fps (4.0MP and lower)	15fps (8.0MP) / 20fps (6.0MP) / 25fps (4.0MP and lower)
<b>Transmission Distance</b>	Rated for up to 700m via 75-3 coaxial cable (performed in ideal test conditions)		
<b>DORI</b>	<b>Detect</b>	53m	84m
	<b>Observe</b>	21m	34m
	<b>Recognise</b>	11m	17m
	<b>Identify</b>	5m	8m
<b>Audio Input</b>	1 channel in & Built-in Mic		
<b>Alarm Interface</b>	N/A		
<b>Video Output</b>	1 x HDCVI / AHD / TVI / Composite video output (switchable via DIP switch)		
<b>Synchronisation</b>	Internal		
<b>OSD Menu</b>	Support		
<b>Ingress Protection</b>	IP67		
<b>Vandal Resistant</b>	N/A		
<b>Housing</b>	Aluminium		
<b>Power Input</b>	12VDC		
<b>Power Consumption</b>	< 7W	< 7W	< 8W
<b>Dimensions</b>	Ø106 x 99mm		
<b>Weight</b>	0.50kg		
<b>Operating Environment</b>	-30° to 60°C / RH90% (max)		
<b>Diagram</b>			
<b>Accessories</b>			
<b>Models</b>	Junction Box (VSBKTA130E)	Wall Mount (VSBKTB204W)	Corner Mount (VSBKTA151 + VSBKTA130E)



# Fixed lens, vandal resistant.

Professional Series: Fixed lens HDCVI domes available in 5.0MP

Experience high performance fixed-lens surveillance in a vandal resistant body. Available in two viewing angles, each dome in this series offers a compact, durable HDCVI upgrade to existing analogue vandal resistant domes.

- Stream up to 5.0MP (2592 x 1944) at 20fps
- Fixed 2.8mm lens with 98° viewing angles
- Up to 700m video transmission over coaxial cable
- Smart infrared illumination, up to 30m range
- HDCVI / AHD / TVI / Analog switchable via DIP switch
- True WDR (120dB) and 2D/3D noise reduction
- IP67/IK10 for weather and vandal resistance
- Superb low light colour performance at 0.005lx

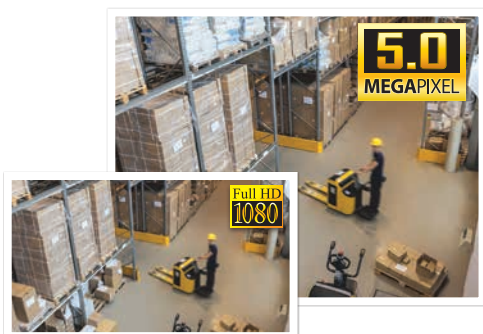

**Up to 9x Image Resolution vs D1**



**DVR Cross Compatibility**



**Weather & Vandal Resistant**

Model		VSCVI-5DIR2.8D						
Camera	Image Sensor	1/2.8" 5.0 Megapixel CMOS						
	Effective Pixels	2592 (H) x 1944 (V)						
	Signal Noise Ratio	> 65dB						
	Lens	2.8mm F1.6 Fixed Lens						
	Angle of View	98°						
	Focus	Fixed / 0.8m Min. Focus Distance						
	Minimum Illumination	0.005 Lux at F1.6 (Colour) / 0 Lux IR Active						
	Electronic Shutter	1/4 ~ 1/100,000s						
	Day/Night	Auto (ICR) / Colour / B&W						
	Infrared Range	30m						
	White Balance	Auto / Manual						
	Noise Reduction	2D / 3D						
	Gain Control	Auto						
Lighting Compensation	BLC / HLC / WDR (120dB)							
Video	Resolution	5.0MP (2592 x 1944) to CIF (352 x 288)						
	Frame Rate	20fps (5.0MP), 25fps (4.0MP and lower)						
	Transmission Distance	Rated for up to 700m via 75-3 coaxial cable (performed in ideal test conditions)						
DORI	Detect	56m						
	Observe	22m						
	Recognise	11m						
	Identify	6m						
Interface	Audio Input	1 channel in						
	Alarm Interface	N/A						
	Video Output	1 x HDCVI / AHD / TVI / Composite video output (switchable via DIP switch)						
	Synchronisation	Internal						
	OSD Menu	Support						
Environmental	Ingress Protection	IP67						
	Vandal Resistant	IK10						
	Housing	Metal, polycarbonate						
	Power Input	12VDC						
	Power Consumption	< 5.3W						
	Dimensions	Ø110 x 81mm						
	Weight	0.33kg						
Operating Environment	-30° to 60°C / RH95% (max)							
Accessories	Diagram							
	Accessories							
Models	Junction Box (VSBKTA136)	Junction Box (VSBKTA123)	Wall Mount (VSBKTB203W)	Wall Mount Rain Shield (VSBKTA200W)	Ceiling Extension (VSBKTA106 + VSBKTB220C)	Right Angle Wall Mount (VSBKTA106 + VSBKTB305W)	Pole Mount (VSBKTB203W + VSBKTA152)	Corner Mount (VSBKTA123 + VSBKTA151)



# Specialist Series

## PTZ, Fisheye, Pinhole & more

### Series Overview

The Specialist Series from Securview™ offers a wide range of specialty HDCVI cameras to tackle challenging or niche coax-based surveillance applications.

View immense detail at a distance with lossless optical zoom PTZ cameras; cover entire rooms with a single camera with Fisheye cameras; and record Full HD video evidence in difficult locations with Pinhole series cameras.

### Model Reference

SKU	Description
VSCVIPTZ-2IRU	2.0MP Ultimate 25x Zoom PTZ Dome
VSCVIPTZ-4IRU	4.0MP Ultimate 30x Zoom PTZ Dome
VSCVI2MPPTZIRBV2	2.0MP Professional 25x Zoom PTZ Dome
VSCVI4MPPTZIRB	4.0MP Professional 30x Series PTZ camera
VSCVI2MPPH3.6	2.0MP Compact Pinhole Camera
VSCVI2MPPIRC	2.0MP Fixed Pinhole Camera with PIR Sensor



#### Stream up to 4.0MP

Stream footage at 9x greater quality than analogue with 4.0MP image resolution.



#### Long Range Optical Zoom

Transform your coax surveillance with up to 30x PTZ lossless optical zoom.



#### Performance Night Vision

Detect objects up to 150m at night with smart infrared technology.



#### Backwards Compatibility

Compatible with analogue & HDCVI DVRs with dual/switchable BNC connectors.



#### Compact & Heavy Duty

The Fisheye Series is heavily protected with IP66 vandal resistant housing



#### Excellent in Low Light

With low light colour (select models), True WDR & auto white balance.



## Series Highlights

### Superb low light performance with ultra low light colour illumination

Capture colour footage even in low ambient light with Ultra Low Light cameras in the Specialist Series. Preserve forensic details that can prove critical in creating usable video evidence.

- Minimum colour illumination at as low as 0.005lx
- Wide dynamic range for challenging lighting
- 100m+ infrared performance for total darkness



### Long range applications with PTZ lossless optical zoom

Cover long distances with the Specialist Series range of PTZ domes.

- 25x & 30x lossless optical zoom models
- Endless 360° panning and -15°~90° tilt
- High manual & preset speed pan-tilt-zoom adjust for camera touring



### Cover whole rooms with one camera with 360° fisheye HDCVI cameras

Eliminate blind spots in your CCTV systems with Fisheye cameras in the Specialist Series. Cover entire rooms with a 360° field of view. Surface mount, ceiling mount or wall mount & dewarp the 360° view for amazing images.

- 5 image dewarp modes; vandal/weather resistant
- Ideal in small rooms, offices, shop fronts, etc.

### Discreet HDCVI surveillance with pinhole series HDCVI cameras

Incorporate surveillance in difficult spaces with Pinhole series HDCVI cameras. Their compact designs are made for delivering discreet surveillance, with optional PIR motion sensing models.

- Smallest camera only 36 x 30 x 22mm in size
- Ideal for small locations in discreet applications such as shelves, inside vehicles, ATMs, etc.





# Versatile CCTV over coax.

Ultimate PTZ Series: HDCVI PTZ domes available in 2.0MP & 4.0MP

Every moment captured with the Securview HDCVI PTZ series. This Ultimate PTZ features colour rendering in low light conditions & up to an incredible 30x optical zoom, the highest viewing distance the Victory Series has to offer.

- Stream up to 4.0MP (2592 x 1520) at 25fps
- Motorised 4.8 ~ 120mm lens, 25x optical zoom (2.0MP)
- Motorised 4.5 ~ 135mm lens, 30x optical zoom (4.0MP)
- Smart infrared illumination, up to 200m range
- IK10 vandal resistant metal housing
- Superb low light colour performance at 0.005lx
- Endless 360° pan, 90° tilt-range and auto-flip 180°
- 2/1 alarm input/output and 1 channel audio input
- True WDR (120dB) and 2D/3D noise reduction
- HDCVI / composite switchable via DIP switches



30x

Up to 30x Optical Zoom Lens



0.005lx

Superb Low Light Performance



200m

Powerful, Long Range Infrared

Model	VSCVIPTZ-2IRU	VSCVIPTZ-4IRU				
<b>Camera</b>						
Image Sensor	1/2.8" 2.0 Megapixel STARVIS™ CMOS	1/3" 4.0 Megapixel CMOS				
Effective Pixels	1920 (H) x 1080 (V)	2592 (H) x 1440 (V)				
Lens	4.8 ~ 120mm F1.6 ~ F4.4 Motorised Lens; Auto Iris	4.5 ~ 135mm F1.6 ~ F4.4 Motorised Lens; Auto Iris				
Angle of View	62.8° (wide) ~ 2.6° (tele) (25x Optical Zoom)	60° (wide) ~ 2.2° (tele) (30x Optical Zoom)				
Focus	Auto/Manual / 0.1m Min. Focus Distance (close focus distance)	Auto/Manual / 1m Min. Focus Distance				
Minimum Illumination	0.005 Lux at F1.6 (Colour, B&W) / 0 Lux at F1.6 (IR on)	0.05 Lux at F1.6 (Colour, B&W) / 0 Lux at F1.6 (IR on)				
Electronic Shutter	1/1 ~ 1/30,000s					
Day/Night	Auto (ICR) / Colour / B&W					
Infrared Range	200m					
White Balance	Auto, ATW, Indoor, Outdoor, Manual					
Noise Reduction	Ultra DNR (2D / 3D)					
Gain Control	Auto / Manual					
Lighting Compensation	BLC / HLC / WDR (120dB)					
<b>Video</b>						
Resolution	1080p (1920 x 1080) / 720P (1280 x 720)	4.0MP (2592 x 1520) / 1080p (1920 x 1080) / 720p (1280 x 720)				
Frame Rate	25/30fps @1080P, 25/30/50/60fps @720P	25/30fps @4MP/1080P, 25/30/50/60fps @720P				
<b>DORI</b>						
DORI Distance	Detect	1613m	2700m			
	Observe	646m	1080m			
	Recognise	323m	540m			
	Identify	161m	270m			
<b>Interface</b>						
Audio Input	1 channel in					
Alarm Interface	2 channel in / 1 channel out					
Video Output	BNC CVI HD output / Composite SD output (switchable via DIP switches on the product)					
OSD Menu	Support					
RS485	1 Input					
<b>PTZ</b>						
Pan/Tilt Range	Pan: 0° ~ 360° endless / Tilt: -20° ~ 90° / Auto-flip 180°					
Manual PTZ Speed	Pan: 0.1° ~ 200°/s; Tilt: 0.1° ~ 120°/s					
Preset PTZ Speed	Pan: 300°/s; Tilt: 200°/s					
Presets	300					
PTZ Modes	5 Pattern / 8 Tour / Auto Pan / Auto Scan					
Protocols	DH-SD / Pelco-P/D (Auto Recognition)					
<b>Environmental</b>						
Ingress Protection	IP67					
Vandal Resistant	IK10					
Housing	Metal					
Power Input	24VAC 3A ±25%					
Power Consumption	17W / 25W (IR On, Heater On)					
Dimensions	Ø209 x 337.4mm					
Weight	9.6kg					
Operating Environment	-40° to 70°C / RH95% (max)					
<b>Accessories</b>						
<b>Accessories</b>						
<b>Models</b>	Included Accessories (AC power supply, VSBKTB305W)	Ceiling Mount (VSBKTB300C + VSBKTA111)	Junction Box (VSBKTA120 + VSBKTA305W + VSBKTA111)	Power Box Mount (VSBKTA140 + VSBKTA305W + VSBKTA111)	Pole Mount (VSBKTA150 + VSBKTA305W + VSBKTA111)	Parapet Mount (VSBKTB3035 + VSBKTA111)



# Rapid 360° scene coverage.

Professional PTZ Series: HDCVI PTZ domes available in 2.0MP & 4.0MP

Every moment captured with the Securview HDCVI PTZ series. This professional PTZ delivers the very best in automated long-range PTZ surveillance with rapid preset camera movement, endless 360° panning and lossless optical zoom.

- Stream up to 4.0MP (2592 x 1520) at 25fps
- Motorised 4.8 ~ 120mm lens, 25x optical zoom (2.0MP)
- Motorised 4.5 ~ 135mm lens, 30x optical zoom (4.0MP)
- Up to 700m video transmission over coaxial cable
- Smart infrared illumination, up to 150m range
- Superb low light colour performance at 0.005lx
- Endless 360° pan, with fast 400°/s pan, 300°/s tilt speed
- 2/1 alarm input/output and 1 channel audio input
- True WDR (120dB) & 3D digital noise reduction
- HDCVI / composite switchable via DIP switches



**30x Optical Zoom Lens**



**Superb Low Light Performance**



**Powerful, Long Range Infrared**

Model		VSCVI2MPPTZIRBV2	VSCVI4MPPTZIRB			
Camera	Image Sensor	1/2.8" 2.0 Megapixel STARVIS™ CMOS	1/3" 4.0 Megapixel CMOS			
	Effective Pixels	1920 (H) x 1080 (V)	2592 (H) x 1520 (V)			
	Signal Noise Ratio	> 55dB	> 55dB			
	Lens	4.8 ~ 120mm F1.6 ~ F4.4 Motorised Lens; Auto Iris	4.5 ~ 135mm F1.6 ~ F4.4 Motorised Lens; Auto Iris			
	Angle of View	59.2° (wide) ~ 2.4° (tele) (25x Optical Zoom)	60° (wide) ~ 2.2° (tele) (30x Optical Zoom)			
	Focus	Auto/Manual / 1m Min. Focus Distance	Auto/Manual / 1m Min. Focus Distance			
	Minimum Illumination	0.005 Lux at F1.6 (Colour) / 0 Lux (B&W) IR Active	0.05 Lux at F1.6 (Colour) / 0 Lux (B&W) IR Active			
	Electronic Shutter	1/3 ~ 1/300,000s	1/1 ~ 1/30,000s			
	Day/Night	Auto (ICR) / Colour / B&W	Auto (ICR) / Colour / B&W			
	Infrared Range	150m	100m			
	White Balance	Auto, ATW, Indoor, Outdoor, Manual	Auto, ATW, Indoor, Outdoor, Manual			
	Noise Reduction	2D / 3D	2D / 3D			
	Gain Control	Auto / Manual	Auto / Manual			
Lighting Compensation	BLC / HLC / WDR (120dB)	BLC / HLC / WDR (120dB)				
Video	Resolution	1080p (1920 x 1080) to CIF (352 x 288)	4.0MP (2592 x 1520) to 720p (1280 x 720)			
	Frame Rate	25fps (1080p and lower)	25fps (4.0MP and lower)			
	Transmission Distance	Rated for up to 700m via 75-3 coaxial cable (performed in ideal test conditions)	Rated for up to 700m via 75-3 coaxial cable (performed in ideal test conditions)			
DORI	DORI Distance	Detect	1613m	2700m		
		Observe	646m	1080m		
		Recognise	323m	540m		
		Identify	161m	270m		
Interface	Audio Input	1 channel in				
	Alarm Interface	2 channel in / 1 channel out				
	Video Output	BNC CVI HD output / Composite SD output (switchable)				
	Synchronisation	Internal				
	OSD Menu	Support				
PTZ	RS485	1 input				
	Pan/Tilt Range	Pan: 0° ~ 360° endless / Tilt: -15° ~ 90° / Auto-flip 180°				
	Manual PTZ Speed	Pan: 0.1° ~ 300°/s; Tilt: 0.1° ~ 200°/s				
	Preset PTZ Speed	Pan: 400°/s; Tilt: 300°/s				
	Presets	300(DH-SD) / 255(Pelco-P/D)	300			
	PTZ Modes	5 Pattern / 8 Tour / Auto Pan / Auto Scan				
	Protocols	DH-SD / Pelco-P/D (Auto Recognition)				
Environmental	Ingress Protection	IP66				
	Vandal Resistant	No				
	Housing	Metal				
	Power Input	24VAC 3A ±10%				
	Power Consumption	13W / 23W (IR active)				
	Dimensions	Ø186 x 309mm				
	Weight	3.5kg				
Operating Environment	-40° to 70°C / RH90% (max)					
Accessories	Diagram					
	Accessories					
Models	Included Accessories (AC power supply, VSBKTB64FB)	Ceiling Mount (VSBKTB300C + VSBKTA110)	Junction Box (VSBKTA120 + VSBKTA300S (Included) + VSBKTA110 (Included))	Power Box Mount (VSBKTA140 + VSBKTA300S (Included) + VSBKTA110 (Included))	Pole Mount (VSBKTA150 + VSBKTA300S (Included) + VSBKTA110 (Included))	Parapet Mount (VSBKTB303S + VSBKTA110 (Included))



# Discreet HD surveillance.

## Pinhole Series: Covert, small profile cameras available in 2.0MP

Designed for discreet surveillance applications, Pinhole Series cameras are ideal for monitoring controlled ingress points, in-shelf surveillance, vehicles and more. Two compact camera styles allow for surveillance in difficult locations.

- Stream up to Full HD/2.0MP (1920 x 1080) at 25fps
- 3.6mm (92°) pinhole and 2.8mm (101°) PIR models
- Up to 700m video transmission over coaxial cable
- Discreet pinhole or motion sensor appearance
- Switchable HDCVI / composite video output
- True wide dynamic range (120dB) (VSCVI2MPPH3.6)
- Auto digital day/night & 2D digital noise reduction
- Includes brackets for wall mounting



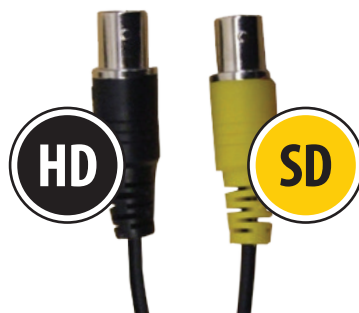

**Up to 5x Image Resolution vs D1**



**Dedicated HD / SD Outputs**

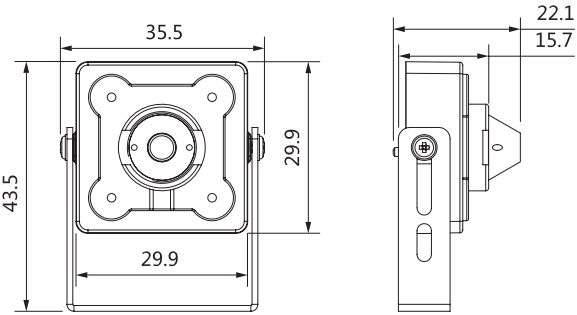
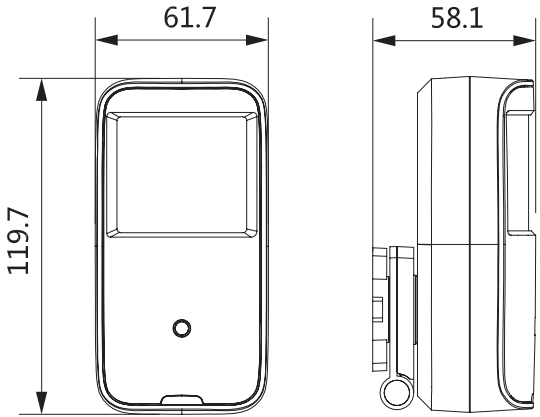

**Pet-Immune PIR Motion Sensor**

Model	VSCVI2MPPH3.6	VSCVI2MPPIRC	
Product Image			
Image Sensor	1/2.8" 2.0 Megapixel CMOS	1/2.9" 2.0 Megapixel CMOS	
Effective Pixels	1937 (H) x 1097 (V)	1920 (H) x 1080 (V)	
Signal Noise Ratio	> 65dB		
Lens	3.6mm F2.4 Fixed Lens	2.8mm F2.0 Fixed Lens	
Angle of View	92°	101°	
Focus	Fixed / 0.6m Min. Focus Distance	Fixed / 0.5m Min. Focus Distance	
Minimum Illumination	0.05 Lux at F2.4 (Colour) / 0.005 Lux at F2.4 (B&W)	0.02 Lux at F2.0 (Colour) / 0.002 Lux at F2.0 (B&W)	
Electronic Shutter	1/4 ~ 1/100,000s	1/25 ~ 1/100,000s	
Day/Night	Auto (ICR) / Manual		
Infrared Range	N/A		
White Balance	Auto / Manual		
Noise Reduction	2D / 3D	2D	
Gain Control	Auto		
Lighting Compensation	BLC / HLC / WDR (120dB)	BLC / HLC / DWDR	
Type	N/A	Passive Infrared	
Range	N/A	12 x 12m (100°)	
Pet Immunity	N/A	≤18kg	
Resistance Light	N/A	6500Lux	
Resolution	1080p (1920 x 1080) to CIF (352 x 288)		
Frame Rate	25fps (1080p and lower)		
Transmission Distance	Rated for up to 700m via 75-3 coaxial cable (performed in ideal test conditions)		
DORI	Detect	51m	44m
	Observe	20m	17m
	Recognise	10m	9m
	Identify	5m	4m
Audio Input	N/A		
Alarm Interface	N/A		
Video Output	BNC CVI HD output / Composite SD output (switchable)		
Synchronisation	Internal		
OSD Menu	Support		
Ingress Protection	N/A		
Vandal Resistant	N/A		
Housing	Metal	Plastic	
Power Input	12VDC		
Power Consumption	< 1.2W	< 0.7W	
Dimensions	35.5 x 30 x 22mm	120 x 62 x 58mm	
Weight	0.09kg	0.13kg	
Operating Environment	-30° to 60°C / RH90% (max)		
Diagram			
Installation height: 2.2 - 2.5m with supplied wall mount bracket			



# Mobile Series HDCVI vehicle surveillance

## Series Overview

Deliver comprehensive vehicle surveillance with Mobile Series HDCVI DVRs and vehicle cameras. Monitor up to 8 cameras on a single vehicle.

Achieve complete vehicle coverage with cameras designed for internal and external applications. Each Mobile Series HDCVI DVR comes standard with high precision GPS tracking, with optional 4G and WiFi modules for remote view.

## Model Reference

SKU	Description
MCVR-GPS4GW	4 Channel Mobile DVR with GPS, 4G & WiFi
MCVR-GPS8GW	8 Channel Mobile DVR with GPS, 4G & WiFi
VSCVI2MPVDIRFTV3	2.0MP Mobile Wedge Dome
VSCVI2MPDIRAT	2.0MP Mobile Dome
VSCVI2MPCIRAT	2.0MP Mobile Bumper
VSCVI2MPBT2.8	2.0MP Mobile Bullet
VSCVI2MPWTT	2.0MP Mobile Dual Lens



### Stream up to 1080p

Stream footage at five times greater quality than analogue with Full HD image resolution.



### Total Vehicle Coverage

Compact camera models enable monitoring inside cabin, cargo, bumper & more.



### GPS Footage Overlay

Using free PC software, view map & GPS data alongside your high resolution footage.



### Capture External Audio

HDCVI mobile cameras feature an inbuilt microphone for capturing outside audio.



### Capture Night Driving Record

HDCVI mobile cameras support up to 20m infrared for night time surveillance.



### Built for the Road

Built with shock resistant & IP67 weather resistant housing for vehicle use.



## Series Highlights

### Purpose built mobile surveillance with robust construction and vibration dampening

Ensure reliable surveillance operation & storage with Mobile Series HDCVI DVRs. Each feature a robust chassis for continued performance in challenging environments encountered by your vehicle.

- Tough extruded aluminium, 1 DIN size chassis
- Vibration dampening HDD mount for reliability
- Lockable HDD caddy, prevents footage theft



### 24/7 vehicle GPS tracking with high precision GPS module

Each Mobile Series DVR features a built-in GPS module so you can include important GPS data as part of your video records.

- Search playback footage by timestamp & location using Google Maps® overlay
- Support video evidence with GPS data

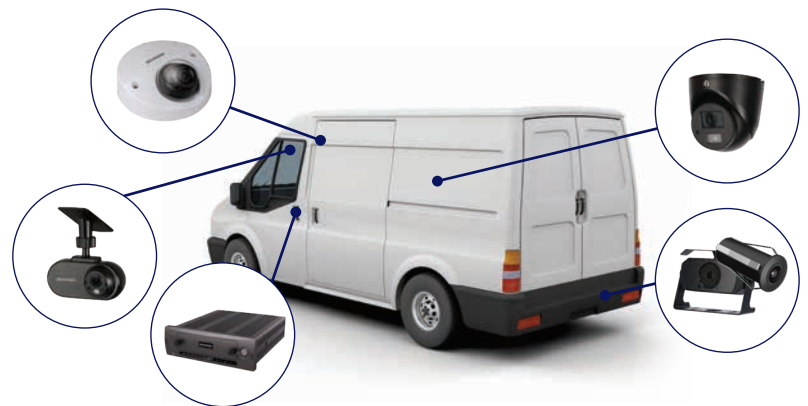

### Every vehicle angle covered with a wide range of Mobile Series cameras

Achieve total vehicle surveillance for safety & security with the Mobile Series. Cover the road ahead, the road behind, inside the cabin and your cargo with the bespoke Securview vehicle camera range.

- Compact dome & bumper cameras for discreet install
- Professional quality dash camera with front/rear view

### Connect remotely to your vehicle with optional 4G and WiFi connectivity modules

Manage larger fleets remotely with 4G and WiFi connectivity. Monitor cabin & cargo, confirm driver locations, identify delays, & perform time critical applications all in real-time.

- Live view and playback vehicle footage via 4G mobile Internet and WiFi
- Backup via WiFi when returned to base





# Mobile HDCVI surveillance.

Mobile DVR Series: HDCVI mobile DVRs in 4 or 8 channels with GPS, 4G & WiFi

The Mobile Series HDCVI DVR range grants peace of mind on the road with Full HD 1080p recording and high precision GPS for vehicle tracking, all in a robust, lockable case. Also available with 4G & WiFi for remote viewing capabilities.

- Records up to Full HD 1080p (1920 x 1080) at 25fps
- Combines video footage with GPS tracking overlay
- Ideal for public transport, cash transit, shipping, etc.
- 1x/2x 2.5" SATA HDD bays & SD card slot up to 128GB
- Audio, alarm, RS485 and RS232 interface inputs
- Robust housing; vibration-dampening construction
- Heavy duty M12 video input connectors
- Single DIN standard size for all models
- Available in 4G & WiFi models to allow mobile remote viewing from anywhere (*SIM not included*)





Full HD 1080p Recording



Footage Playback GPS Overlay

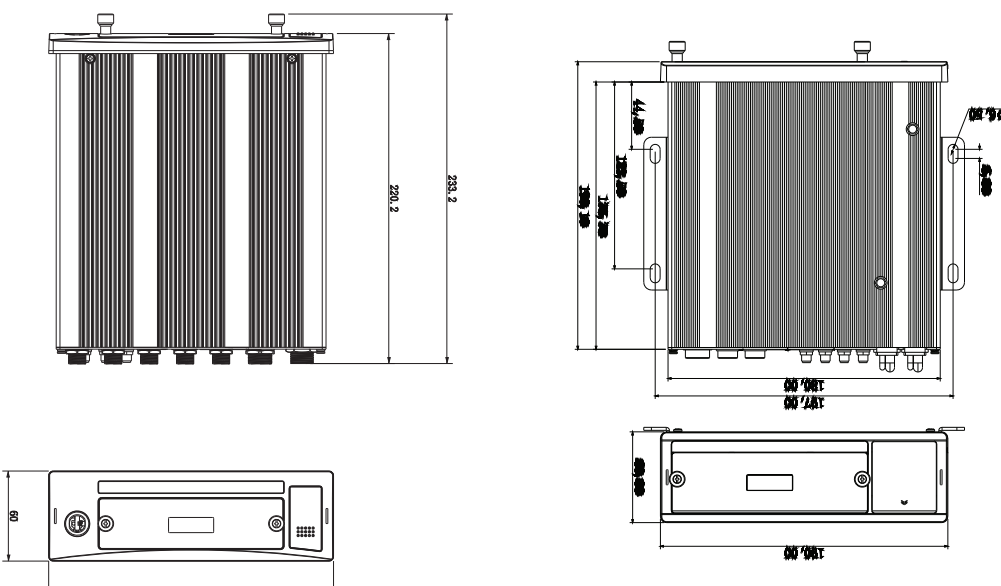

Use with Most Analogue Cameras

Model	MCVR-GPS4GW	MCVR-GPS8GW
Product Image		
Product Variants by Model	MCVR-GPS4GW: Includes GPS, 4G & WiFi	MCVR-GPS8GW: Includes GPS, 4G & WiFi
Main Processor	Embedded Processor	
Operating System	Embedded Linux	
Video Input	4 channel HDCVI / Analogue	8 channel HDCVI / Analogue
Camera Configurations	2 channels up to 1080p/25fps + 2 channels up to 720p/25fps (HDCVI), 4 channels up to 960H/25fps (analogue)	8 channels up to 1080p/25fps (HDCVI), 8 channels up to 960H/25fps (analogue)
Audio In/Out	4 / 1	8 / 1
Two-way Talk	Reuse channel 1 audio input/output	
Video Output	1 x VGA / 2 x TV	
Display Resolution	1920 x 1080 to 800 x 600	
Display Split	1 / 4	1 / 4 / 8 / 9
OSD	Camera title, time, video loss, camera lock, motion detection, recording	
Maximum Resolution	1080p (1920 x 1080) / 720p (1280 x 720)	
Frame Rate	Main: 2CH 1080p (1~25fps) + 2CH 720p (1~25fps) Sub: 960H (1~6fps) / CIF (1~25fps)	Main: 1080p (1~25fps) Sub: 960H (1~6fps) / CIF (1~25fps)
Video Compression	H.264 / G.711	
Bit Rate	48~8192Kbps	
Record Modes	Manual / Schedule (Regular, Continuous), Motion Detection, Alarm, Stop	
Record Interval	1~120 min (default: 60 min) / Pre: 1~30s / Post: 10~300s	
Alarm Input / Output	7 / 2	
Trigger Events	Recording; PTZ; tour; alarm; email notification; FTP upload; internal buzzer; and screen tip overlay	
Video Detection	MD zones: 396 (22 x 18) / Video loss / Camera blank	
Playback Sync	1	1/4
Search Modes	Time/Date; Motion detection; Exact search	Time/Date; Alarm; Motion detection; Exact search
Backup Modes	USB Device / Network	
Ethernet	1x RJ-45 port (10/100M)	1x RJ-45 port (10/100/1000M)
GPS	Built-in highly accurate GPS module / Overlay: car number, time, position, speed	
Network Functions	TCP/IP, UDP, DHCP, DDNS, FTP, Email, Alarm Server	
Max. User Access	128 users	
Remote View	iOS (iPhone, iPad); Android devices, Windows Phone (Requires optional 3G/4G module)	
Internal HDD	1 x 2.5" SATA port / 1 x SD card slot, up to 128GB	2 x 2.5" SATA ports / 1 x SD card slot, up to 128GB
USB Interface	2 ports: 2 x USB2.0 (rear)	3 ports: 2 x USB3.0 (front), 1 x USB2.0 (rear)
Auxiliary Inputs	1 x RS232 / 1 x RS485	
Power Supply	6 ~ 36VDC	
Power Consumption	<15W (without HDD)	<12W (without HDD)
Operating Environment	-30 ~ +60°C / 0~90%RH	
Dimensions	178mm x 220mm x 50mm	180mm x 190mm x 50mm
Weight	2.1kg (without HDD)	2.2kg (without HDD)
Additional Information		
	<p>MCVR-CABLE - Heavy duty aviation-style connector (M12) coaxial camera cable in 3m, 6m, 12m and 18m. Also available, 30cm VGA cable.</p>	



# Built for road performance.

**Mobile Series: Full HD 1080p HDCVI mobile surveillance cameras in 2.0MP**

Keep every angle of your vehicle covered with Mobile Series surveillance cameras from Securview. Choose from vandal dome, compact dome & bumper cameras, capable of Full HD streaming in durable IP67 rated housings.

- Stream 2.0MP / Full HD 1080p (1920 x 1080) 25fps
- Fixed lens, available in 111° to 83° viewing angles
- Smart infrared illumination, up to 20m range
- Built-in microphone mobile series models available
- IP67 weather resistant metal housings (all models)
- Shock resistant housings with aviation connectors
- DIRFT dome: Low profile & IK10 vandal resistant
- DIRAT dome: Smaller than a tennis ball Ø62 x 62mm
- CIRAT camera: Ideal for bumper placement
- BT camera: Ideal for flush mount in-bumper









**Built-in Mic Models Available**



**20m Infrared and low light vision**

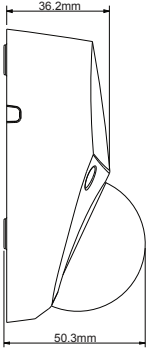
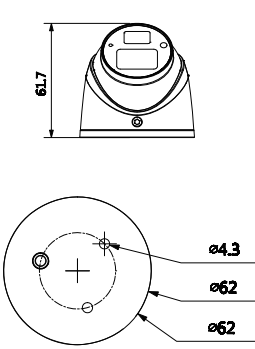
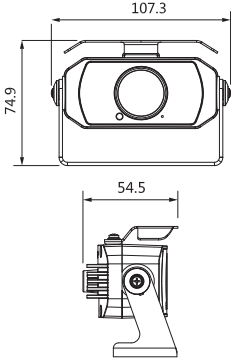
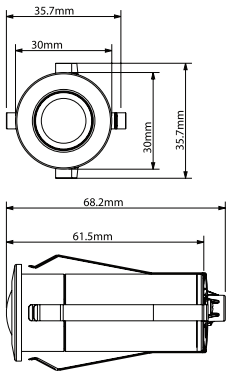

**IP67 Rated Across the Range**

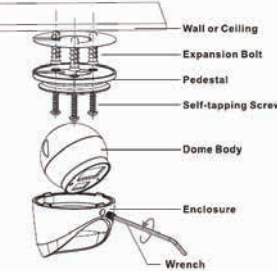
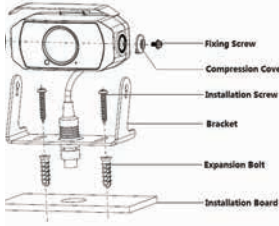
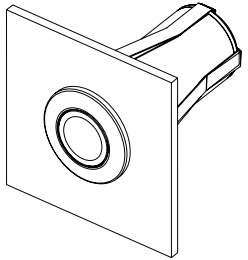
Model		VSCVI2MPVDIRFTV3	VSCVI2MPDIRAT	VSCVI2MPCIRAT	VSCVI2MPBT2.8	
General	Product Image					
	Camera Style	Mobile Wedge Dome	Mobile Dome Camera	Mobile Bumper Camera	Mobile Bullet Camera	
	Image Sensor	1/2.8" 2.1 Megapixel CMOS		1/2.9" 2.0 Megapixel CMOS		
	Effective Pixels	1920(H)×1080(V)		1920 (H) x 1080 (V)		
	Signal Noise Ratio	> 65dB				
Camera	Lens	3.6mm F1.6 Fixed Lens	3.6mm F2.0 Fixed Lens	3.6mm F2.0 Fixed Lens	2.8mm F2.0 Fixed Lens	
	Angle of View	110°	83°	83°	109°	
	Focus	Fixed	Fixed / 0.8m Min. Focus Distance	Fixed / 0.8m Min. Focus Distance	Fixed / 0.5m Min. Focus Distance	
	Minimum Illumination	0.005 Lux at F1.6 (Colour) / 0 Lux IR Active	0.02 Lux at F2.0 (Colour) / 0 Lux IR Active	0.02 Lux at F2.0 (Colour) / 0 Lux IR Active	0.02 Lux F2.0 (Colour) / 0.002 Lux (B/W)	
	Electronic Shutter	1/4 ~ 1/100,000s		1/25 ~ 1/100,000s		
	Day/Night	Auto (ICR) / Manual				
	Infrared Range	20m	20m	20m	N/A	
	White Balance	Auto / Manual				
	Noise Reduction	2D / 3D		2D		
	Gain Control	Auto				
	Lighting Compensation	BLC / HLC / WDR (120dB)		BLC / HLC / DWDR		
	Video	Resolution	1080p (1920 x 1080) to CIF (352 x 288)			
Frame Rate		25fps (1080p and lower)				
Transmission Distance		3m / 6m / 12m / 18m heavy duty cables available				
DORI	DORI Distance	Detect	55m	57m	57m	40m
		Observe	22m	23m	23m	16m
		Recognise	11m	11m	11m	8m
		Identify	6m	9m	6m	4m
Interface	Audio Input	N/A	Built-in microphone	Built-in microphone	N/A	
	Alarm Interface	N/A				
	Video Output	1x BNC HDCVI output				
	OSD Menu	Support				
Environmental	Ingress Protection	IP67				
	Vandal Resistant	IK10		N/A		
	Housing	Metal, Polycarbonate		Metal		
	Power Input	12VDC				
	Power Consumption	<3.6W	<2.9W	<2.9W	<0.6W	
	Dimensions	Ø106 x 50mm	Ø62 x 62mm	107 x 43 x 55mm	Ø30 x 68mm	
	Weight	0.31kg	0.16kg	0.31kg	0.07kg	
Operating Environment	-40° to 60°C / RH90% (max)					
Accessories	Product Diagram					
	Compatible Brackets	 Mobile Shield (VSBKTA201W) Junction Box (VSBKTA139)				



# Road and cabin coverage.

## Mobile Series: Full HD 1080p HDCVI dual-lens mobile dash camera

Designed for windshield mounting, this dual lens vehicle camera simultaneously records Full HD evidence inside and outside the vehicle. Equipped with a built-in microphone and features a durable shock resistant housing.

- Stream 2.0MP / Full HD 1080p (1920 x 1080) at 25fps
- Fixed lens - 116° external and 139° internal
- Innovative dual-lens design records 2 images at once
- Smart in-vehicle infrared illumination up to 3m
- Features built-in microphone for audio evidence
- Robust aviation style connector cables
- Slimline design with shock resistant housing
- Easy installation to the inside of the windshield

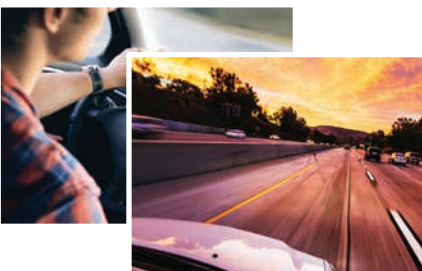

**Simultaneous Driver/Road Recording**



**Smart In-Vehicle Infrared up to 3m**



**Built-in Audio Recording**

<b>Model</b>	<b>VSCVI2MPWTT</b>		
<b>Camera Style</b>	Mobile Dual Lens Camera		
<b>Image Sensor</b>	1/2.7" 2.0 Megapixel CMOS		
<b>Effective Pixels</b>	1920 (H) x 1080 (V)		
<b>Signal Noise Ratio</b>	> 65dB		
<b>Lens</b>	<b>Front:</b> 2.8mm F2.0 Fixed Lens / <b>Rear:</b> 2.1mm F2.0 Fixed Lens		
<b>Angle of View</b>	<b>Front:</b> 116° / <b>Rear:</b> 139°		
<b>Focus</b>	Fixed		
<b>Minimum Illumination</b>	0.02 Lux at F2.0 (Colour) / 0 Lux IR Active		
<b>Electronic Shutter</b>	1/25 ~ 1/100,000s		
<b>Day/Night</b>	<b>Front:</b> Color / <b>Rear:</b> Auto (IRC)		
<b>Infrared Range</b>	<b>Front:</b> 3m Infrared / <b>Rear:</b> N/A		
<b>White Balance</b>	Auto / Manual		
<b>Noise Reduction</b>	2D		
<b>Gain Control</b>	Auto		
<b>Lighting Compensation</b>	BLC / HLC / Digital WDR		
<b>DORI Distance</b>	<b>Front:</b> Detect: 37.3m / Observe: 14.9m / Recognise: 7.5m / Identify: 3.7m <b>Rear:</b> Detect: 35.5m / Observe: 14.2m / Recognise: 7.1m / Identify: 3.5m		
<b>Resolution</b>	1080p (1920 x 1080)		
<b>Frame Rate</b>	25fps (1080p and lower)		
<b>Transmission Distance</b>	3m / 6m / 12m / 18m heavy duty cables available		
<b>DORI</b>	<b>DORI Distance</b>	<b>Detect</b>	Front: 37.3m(122.4ft) / Rear:35.5m(116.5ft)
		<b>Observe</b>	Front: 14.9m(48.9ft) / Rear: 14.2m(46.6ft)
		<b>Recognise</b>	Front: 7.5m(24.6ft) / Rear: 7.1m(23.3ft)
		<b>Identify</b>	Front: 3.7m(12.1ft) / Rear: 3.5m(11.5ft)
<b>Interface</b>	<b>Audio Input</b>	Built-in microphone	
	<b>Alarm Interface</b>	N/A	
	<b>Video Output</b>	2x BNC HDCVI output (Yellow: front / Black: rear)	
	<b>OSD Menu</b>	Support	
<b>Environmental</b>	<b>Ingress Protection</b>	N/A	
	<b>Vandal Resistant</b>	N/A	
	<b>Housing</b>	Plastic	
	<b>Power Input</b>	12VDC ±25%	
	<b>Power Consumption</b>	<2.4W	
	<b>Dimensions</b>	116 x 100 x 50mm	
	<b>Weight</b>	0.13kg	
<b>Operating Environment</b>	-30° to 60°C / RH95% (max)		

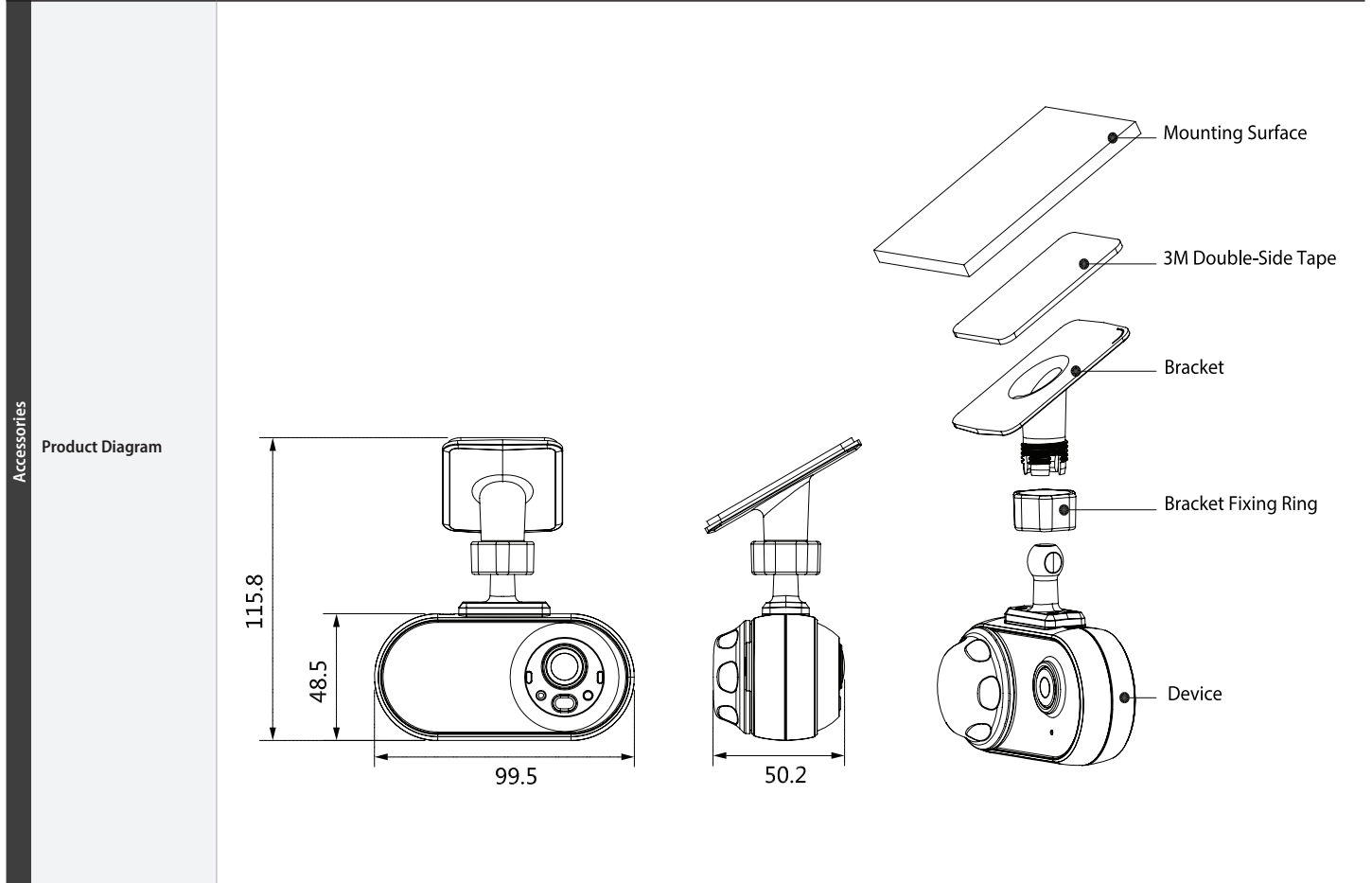



# Extend HDCVI surveillance.

Deliver your surveillance to more areas with HDCVI video decoders

Easily extend your HDCVI surveillance to additional displays with the Securview Victory Series HDCVI decoder. These are ideal for spot surveillance retail stores, in guard or security management centres & more.

- Convert HDCVI input to HDMI, VGA & Composite output
- Convert HDMI input to HDCVI (BNC) output
- Supports 1080p / 720p resolutions (HDCVI/HDMI/VGA)
- Auto adjustment of output signal to the input signal
- Stream live camera footage directly to a spot monitor
- Real time transmission, lossless, uncompressed video
- LED indicators show power/video/data status
- Fully enclosed dustproof design with wall mount kit



Create Spot Monitors for HDCVI Cams



Output Video to HDMI, VGA & Coax



Full HD, lossless video transmission



Model		VSCVIDECODER
Input/Output	Input Ports	HDCVI (BNC)
	Output Ports	HDMI, VGA, Composite (BNC), HDCVI (BNC)
	Input & HDCVI Output Transmission Distance	1080p/720p: Up to 100m (75-5 coaxial)
	Dial Switch	2 x Dial Switches control Baud rate: 2400b/s, 4800b/s, 9600b/s, 115200b/s
	Supported Resolutions	720p / 1080p @ HDCVI / HDMI / VGA Composite Video (Composite) - PAL/NTSC auto detection
General	LED Status Indicators	Power / Video / Data
	Power Supply	12VDC 2A
	Power Consumption	≤8W
	Operating Environment	-10 ~ 55°C / 10 ~ 90%RH
	Dimensions	162 x 136 x 30mm
	Weight	0.2kg
	Installation	Wall Mount
Product Image		

## Create spot monitors & extend video output using HDCVI encoder/decoders:

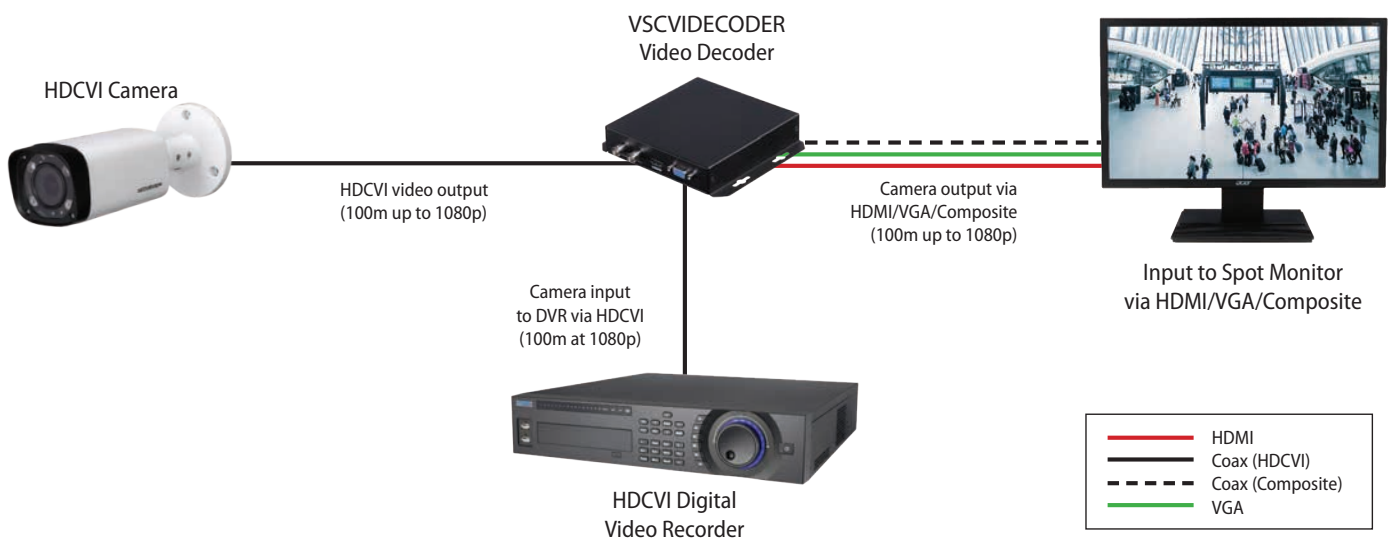

## Want to increase your number of surveillance monitor displays?

Want to view your surveillance cameras on multiple display monitors or create a video wall? Check out the NVD-A series from VIP Vision™. With the NVD- A you can configure up to 9 HDMI displays, allowing you to create video walls that will display live footage from any camera or recorder connected to the network. The NVD-A Series decoders can be fully configured and adjusted over the network or by Smart PSS.





# Versatile coaxial accessories.

Change video output, transfer network data over coaxial and more.

The Securview HDCVI Accessories range helps you make the most out of existing coaxial installations. Check & change coax camera video output, re-purpose coaxial cable for IP surveillance, fix ground loop interference and more.

- Have the perfect solution to any coaxial installation
- Supports HDCVI / TVI / AHD / Analogue configurations
- Check & change coaxial camera video output; no DVR or monitor required
- Eliminate interference caused by ground loops
- Save on wiring costs by transferring HDCVI / analogue video over CAT6 or CAT5e Ethernet cable
- Use existing coaxial cable for IP security installations



**Test, Check & Change Video Output**



**Remove Ground Loop Interference**



**Use Existing Coaxial for IP Installations**

## UTC Video Output Controller Model: VSSELECT101



The VSSELECT101 UTC Video Output Controller changes the video output format of coaxial cameras to HDCVI, TVI, AHD or Analogue. This allows you to configure camera video outputs by simply connecting the VSSELECT101 and pushing a button, saving the hassle of setting up a DVR and monitor for configuration.

When pressed, the Enter button lights up to display the current video output of the connected camera.

- Supports HDCVI / TVI / AHD / Analogue config
- Simple plug-and-play functionality
- Lights up to show current video output format
- 560mm cable length, 2 x AAA battery



## HDCVI Video Isolator

Model: VSGLI

This HDCVI video isolator effectively solves the image interference caused by ground loops.

- 75Ω BNC male to female
- 100MΩ insulation resist
- 800V isolation voltage, 600V contact ESD
- 4KV 10/700us surge protection
- 400mm cable length

## HDCVI Balun Pair

Model: VSBALHDP

Minimise the cost of wiring for camera installs with network cabling such as CAT6 or CAT5e instead of Coax Cable.

- Transmit HDCVI or composite video over CAT5e or CAT6 Ethernet cable
- 400m@720p max.
- 250m@1080p max.
- UTP terminal block

## Ethernet over Coax Extenders

Model: VSEOC-ATX/ARX & VSEOCPAIRV2

Repurpose existing coaxial cabling to be used with IP security systems, including PoE. (See diagrams below for examples.)

- Extend Ethernet/Power from PoE switch over coax
- Range includes transmitter, receiver & converter
- Extend over coax up to 400m@100Mbps and up to 1000m@10Mbps (using RG59 coax)
- Supports IEEE802.3 & IEEE802.3u standards

## Re-use existing coax cable for IP installs with the Securview Accessories range

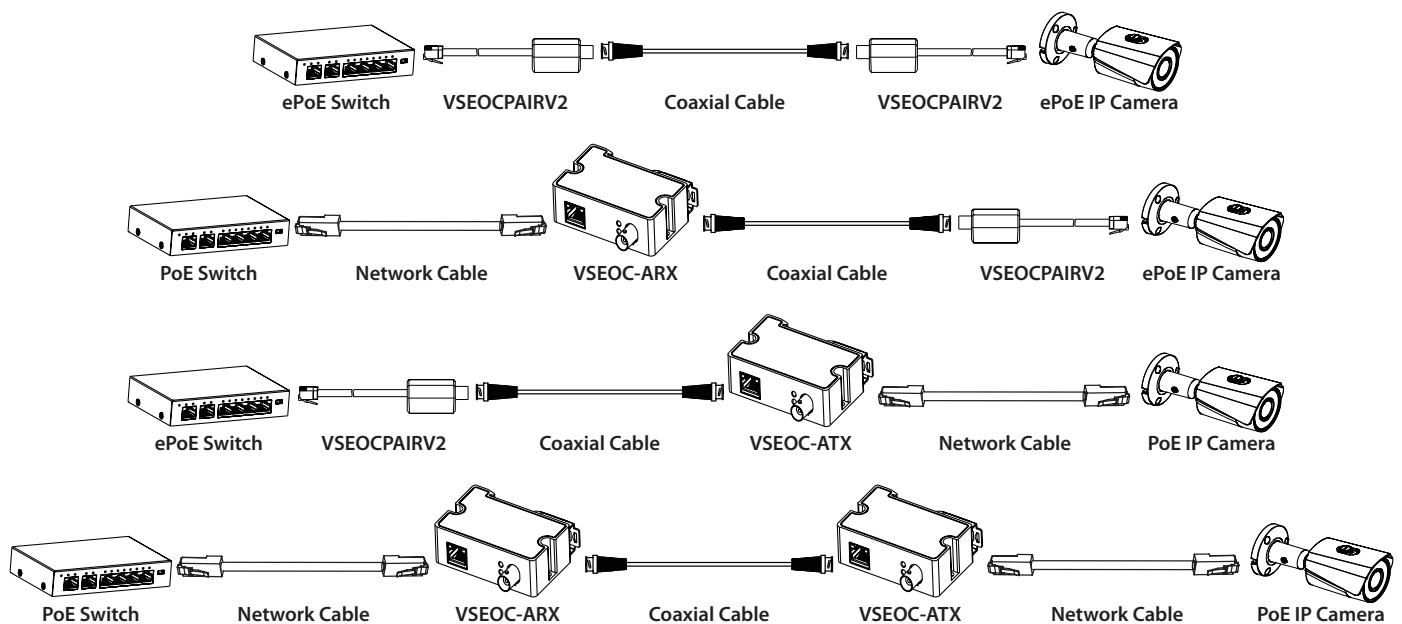



## Securview™ Smart PSS Desktop Surveillance Management Client

Securview™ Smart PSS client for Windows and Macintosh OS X offers simple & free surveillance management for your desktop PC or laptop. This is the perfect CCTV management client to use with your home or business computer or laptop.

- Easily connect to the surveillance systems on the network and even setup local footage recording to your PC or laptop (optional).
- Live view up to 64 cameras at a time, take image snapshots, record footage, output to video wall, integrate alarm/audio and more.
- Make CCTV the ultimate business management tool: Monitor staff behaviour, identify inefficient processes, qualify complaints, confirm deliveries and prevent WHS incidents.



### Ease of Use

Swift, remote interaction with your CCTV surveillance. Group cameras, set up tours and pan-tilt-zoom, using and responsive drag and drop controls.



### Connect Quickly

Easily connect to all CCTV cameras and recorders on your network, with support for up to 256 devices and up to 2000 camera channels.



### Organise via eMap

The surveillance eMap overlay allows you to build a virtual map of your camera locations, enabling easy CCTV access & organisation, even in large premises.



### Fisheye Dewarp

Manipulate live view and stored footage of your Securview Fisheye dome cameras using the Smart PSS client.



### Account Management

Comprehensive user account setup and control, with detailed permission settings, user role allocation, system logs and more.



## Securview™ DMSS Mobile Surveillance Management Client

Monitor and act upon surveillance & intercom alerts all from your smartphone or tablet all with the Securview™ DMSS application. Enjoy deep surveillance & intercom interaction, all from the convenience of your mobile device.

- Connect your mobile phone or tablet to your surveillance quickly with remote view setup via QR code, available with most Securview DVRs.
- Take snapshots, record footage, playback DVR-stored footage, pan-tilt-zoom your cameras and more, all remotely via your smart device.
- Also configure your smartphone to act as a intercom monitor. Answer visitors, monitor the door station camera & even remote unlock your door from anywhere.



### Intuitive Touch Interface

Easily access your surveillance or intercom system using the intuitive touch menu system. Take snapshots, pan-tilt-zoom & more from your device.



### Easily Add Devices

Connect your mobile phone or tablet quickly via QR code. Simply connect your DVR to the Internet and scan the QR code via the app to get up and running.



### Respond Instantly

Receive and respond to push notifications of surveillance, alarm trigger and intercom events directly from your smart device.



### Remote Unlock

Always appear to be at your premises, even when you aren't - answer door visitors, video/audio chat, unlock doors or simply monitor from Flashview.



### Prevent Data Overages

Configure your device to connect to lesser-quality surveillance streams (sub or third stream) to consume less mobile data when remotely accessing surveillance.

# Feature Glossary

Common terminology for Securview Victory Series™ HD video over coaxial surveillance cameras and digital video recorders.

## Auto-Tracking

Auto-tracking allows the tracking action to be triggered manually or automatically by defined rules. Once rules are triggered, the camera can zoom in and track the defined target automatically.

## Back Light Compensation

This is a feature of security cameras that automatically adjusts the image to compensate for bright light to give more detail on the darker areas of the image. For example, it is used to focus on the detail of a face of a person that has sunlight shining from behind.

## Corridor Mode/Image flip

Capturing unnecessary data such as surrounding hallway walls can increase storage requirements without any added value. The image flip feature allows the camera's image to be rotated in 90° increments for better video optimization.

## Digital Noise Reduction (2D/3D DNR)

2D/3D DNR incorporates frame-to-frame noise reduction with spatial noise reduction to produce clear video images with less noise, in low light conditions. Noise reduction is critical for video because noise affects image quality. Cameras with 2D + 3D DNR produce sharper, more accurate video images with less ghosting.

## Face Detection

Detects and stores snapshots of human faces. Select playback by Face Detection to scroll through a list of captured faces with timestamps, cutting down time on searching playback.

## Fisheye Dewarping

Dewarping 360° fisheye images for usable surveillance images. Display of multiple views simultaneously taken from a single 360° camera and manipulate playback footage with virtual PTZ mode and a variety of ceiling, floor and wall mount dewarp options.

## HDCVI

The premier HD-video-over-coax transmission standard, HDCVI standards for High Definition Composite Video Interface.

## Heat Map (Intelligent Video Surveillance)

Records crowd density statistics via motion detection within a set time range, displaying in different colours. Crowd density ranges from high to low, with red representing high density and blue low density.

## Intrusion Detection (Intelligent Video Surveillance)

Alarm, record or snapshot will be triggered when the target is entering or leaving the defined area.

## Object Abandoned / Missing (Intelligent Video Surveillance)

Alarm, record or snapshot will be triggered, when the target is abandoned/removed in the designated area and exceeds the set time.

## People Counting

Produces statistics of people entering and leaving the specific area of the image. Produces different types of data reports: select daily, monthly or yearly reports; then export data for analysis.

## Regions of interest

Regions of Interest (ROI) is a user defined feature that allows the operator to monitor specific areas of a scene while still maintaining overall situational awareness of less important areas, eg: fix a region of interest on a vehicle number plate in a driveway scene.

## Scene Change Detection

Alarm, record or snapshot will be triggered when the video scene is changed due to external factors such as turning the camera angle manually or covering over the lens.

## Smart Infrared

Cameras with Smart Infrared technology adjust their infrared LED intensity to compensate for the distance of an object to prevent over exposure. This reduces cases of washed out of images due to the intensity of camera infrared.

## Tripwire Detection (Intelligent Video Surveillance)

Alarm, record or snapshot will be triggered when the target passes through the warning line according to the movement direction set. Different direction selections, such as A->B, B->A and bi-directional.

## True Day/Night

This feature consists of a automatic mechanical IR cut filter that is removed when making the camera ideal for applications with fluctuating lighting conditions, delivering color images during the day and automatically switching to monochrome as the scene darkens.

## Ultra Low Light Technology

We use the latest image processing algorithm, high performance hardware and high quality optical components, allowing the camera to deliver clear, bright and low-noise color images in extremely low light conditions.

## Victory Synergy

The term used to describe DVRs that support other major HD-video-over-coax technologies (HDCVI, HDTVI, AHD), as well as supporting analogue and IP video inputs.

## Wide Dynamic Range

Embedded with industry leading wide dynamic range (WDR) technology, vivid pictures are achieved even in the most intense contrast lighting conditions. For applications with both bright and low lighting conditions that change quickly, True WDR (120dB) optimizes both the bright and dark areas of a scene at the same time to provide usable video.



## Stay connected with all that you love.™

Achieve more than security with Securview and the DMSS smartphone app. Receive instant surveillance alerts, live view your cameras, take snapshots and even remotely playback stored footage. Do this and more from anywhere with your Securview HDCVI surveillance system and DMSS.



# SECURVIEW

VICTORY SERIES

Contact your local Securview HDCVI surveillance professional:



[www.securviewcctv.com](http://www.securviewcctv.com)