

Adapter for Ceiling & Wall Mount Brackets

Model: VSBKTA101

Technical Specifications

Powder coated aluminium adapter to enable camera/bracket connection for ceiling and wall mount brackets.

Model	VSBKTA101
Materials	Aluminium
Dimensions	Ø159 x 35mm
Pipe Thread	1½" PF
Operating Conditions	-40° ~ 60°C / 90% RH (max)
Load Bearing Capacity	N/A
Weather Resistance	N/A
Weight	0.24kg



Product specifications and bracket compatibility are subject to change.

Bracket Compatibility

This bracket is compatible with the following cameras from VIP Vision and/or Securview Victory Series.



VIP Vision™ IP Surveillance Cameras

Adapter compatible with VSBKTB300C ceiling mount bracket and VSBKTB302S wall mount bracket.



Securview Victory Series™ HD Over Coax Cameras

Adapter compatible with VSBKTB300C ceiling mount bracket and VSBKTB302S wall mount bracket.

Product Diagrams

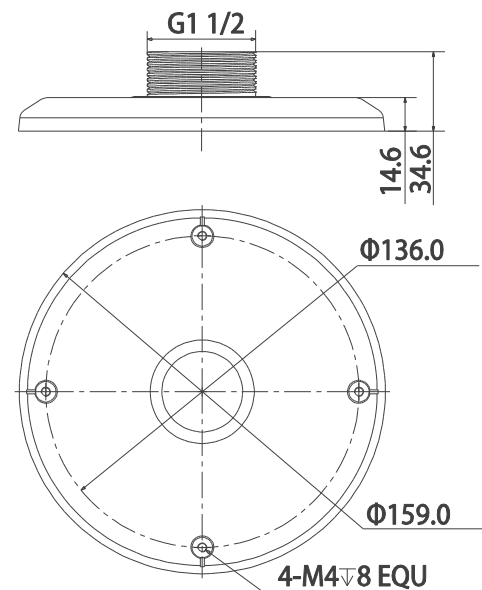

Your professional CCTV surveillance dealer: