



Solar IP Camera System

SLR-B Series Quick Install Guide







Version: VIPSLRB-Q121

1. Product Information

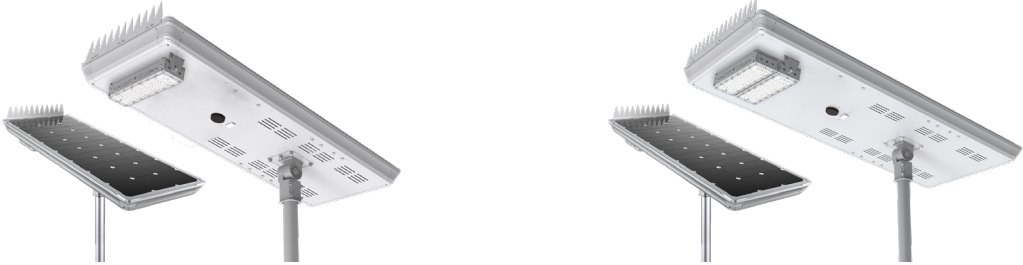
1.1 Included Components

Thank you for purchasing a VIP Vision Solar Surveillance System.

Below is a list of what is included with the standard Solar Surveillance System. Please note that this can vary, depending on the customization options selected. Please refer to the included configuration sheet for specific product details.

Solar Panel				
Image				
Panel Model	120		180	
Panel Type	120W monocrystalline silicon panel		180W monocrystalline silicon panel	
Conversion Rate	Up to 21% efficiency			
Battery	12.8V/500Wh Lithium Iron Phosphate (LiFePO4) w/ Low Voltage Cutoff		25.6V/1200Wh Lithium Iron Phosphate (LiFePO4) w/ Low Voltage Cutoff	
Dimensions	1321 x 525 x 161mm		1496 x 685 x 161mm	
Panel Adjustment	-60° ~ 60° tilt adjustable with angle compass			
Ingress Protection	IP65			
Wind Resistance	Up to 65m/s			
Dimensions	Ø50 ~ 60mm			
Area Light				
Light Module	50W LED (3030 Philips), 9400lm (180lm/W)		60W LED (3030 Philips), 11100lm (180lm/W)	
Light Characteristics	145° x 100° (batwing) beam angle / 5700K cool white / 50,000hrs rated lifespan			
Motion Detection	Microwave motion sensor, Ø8 ~ 15m range (at 10m height)			
Adjustable Settings	Normal & Morning time periods / Brightness on motion / On-time delay / Brightness after delay			
Light Adjustment	-30° ~ +30° tilt adjustable LED module			
Camera				
Camera Options			<p>4.0MP Mini AI PTZ Dome 2.8 ~ 12mm Motorised lens 31.6° ~ 96.9° (4x optical zoom) Pan: 0° ~ 355° / Tilt: 5° ~ 90° IP66 weather resistant IK08 vandal resistant Video analytics (tripwire etc.) Perimeter protection to identify people & vehicles</p>	
Connectivity				
Inclusions and Optional Accessories				
	<p>Solar CCTV Assembly (included) Mounting kit with backing box and triple-clamp pole mount (pole not incl.)</p>	<p>256GB MicroSD (included) 256GB surveillance grade microSD card for footage recording</p>	<p>3G/4G LTE Modem Router (option) LTE connectivity up to 150Mbps speeds 4G: FDD 700/900/1800/2100/2600; TDD 2300Mhz *SIM card & service charges not included</p>	<p>5.8GHz Wireless Links (option) 2 x 5.8GHz wireless antennas 120° beam width, 25dBi gain Pair configured as network bridge</p>

1.2 Optional Mounting Components

Below are optional mounting components; please contact your supplier for more information.



4.5m Hinged Galvanised Pole
SLR-POL4.5H
 Includes 1 x Pole



Unassembled Solar Base
SLR-POLBASE
 Includes 1 x Base, 4 x Mounting Bolts, 1 x Bolt
 Template & 1 x Steel Reinforcement Cage
On-site assembly required
Concrete not included



Assembled Solar Base
SLR-POLCONC
 Includes 1 x Base, 4 x Mounting Bolts, 1 x Bolt
 Template, 1 x Steel Reinforcement Cage &
 Concrete
Assembled off-site

1.3 Solar Panel Information



120W/180W Solar Panel with Motion-Sensing Street Light

This solar panel system is fitted with undervoltage protection, which disconnects the load at approximately 10.8V (SLR-B120) or 21.6V (SLR-B180). If you are not receiving any voltage on the output wires, place the panel in direct sunlight for a minimum of one hour and re-test.

The output will be reconnected automatically when battery voltage reaches approximately 11.5V (SLR-B120) or 23.0V (SLR-B180). For more information on panel configuration, refer to Section 4.

The solar panel must be installed in direct sunlight. Shade will negatively impact performance.

This solar panel includes a motion-activated LED light. For more information, refer to Section 4.

1.3 Solar Panel Information (continued)

Solar Panel Assembly Diagram

Lamp Arm

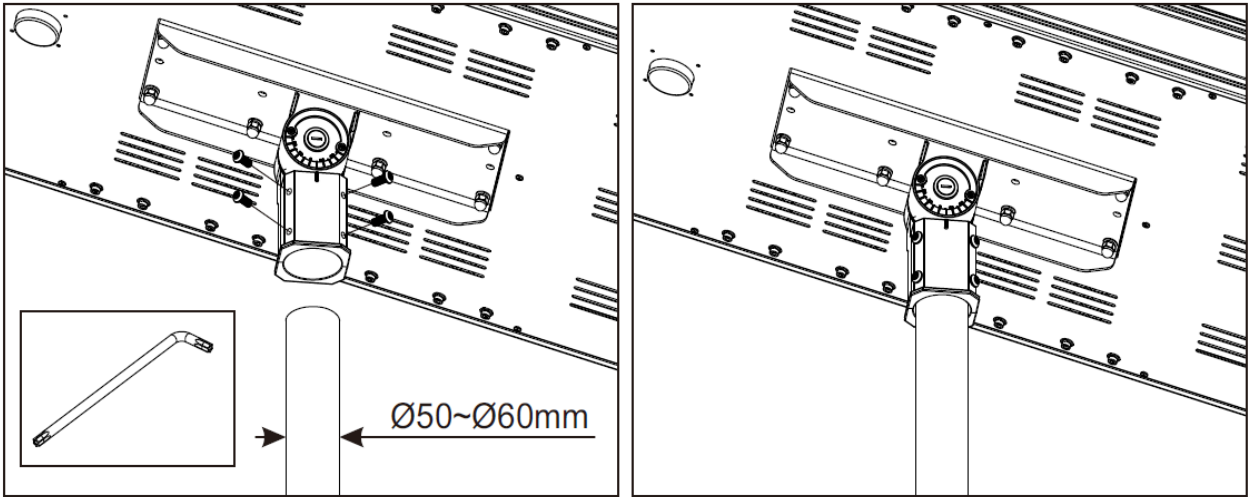

Bird Spikes

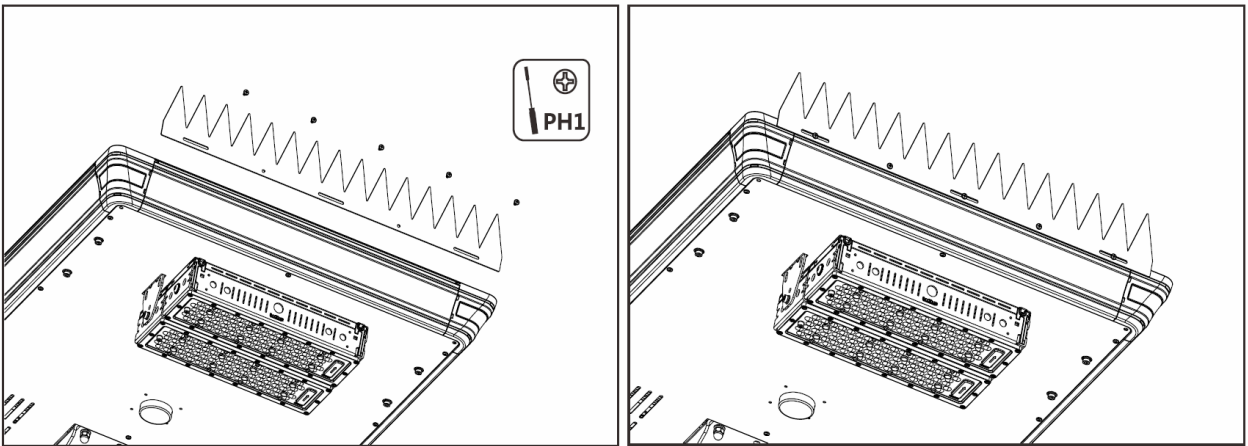

Accessories

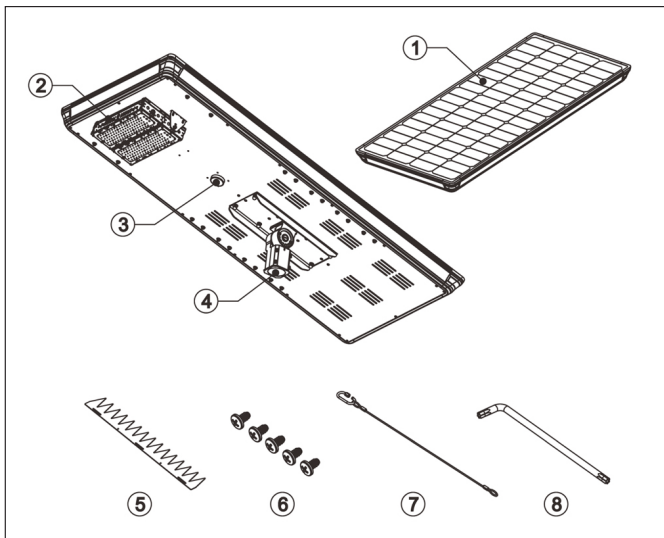

#	Component
1	Solar panel
2	LED light
3	Microwave sensor
4	Lamp arm
5	Bird spikes
6	Screws
7	Safety rope
8	T40 Torx

1.4 Camera Information

The camera has been pre-installed with a 256GB microSD card and has been preconfigured to record at its maximum resolution.

The username and password details for the camera can be found on the configuration sheet inside the junction box. The default username is **admin**.

To prevent unauthorised access, ensure you change the admin password before completing installation.

Default Camera Configuration

Main Stream

Stream Type	General
Encode Type	H.265
Resolution	Camera max
FPS	15
Encoding Method	Constant Bit Rate
Quality	6 (Best)
Bit Rate	1536-8192Kbps
I Frame Interval	30

Sub Stream

Stream Type	General
Encode Type	H.265
Resolution	D1 (704 x 576)
FPS	15
Encoding Method	Variable Bit Rate
Quality	4 (Good)
Bit Rate	512Kbps
I Interval	30

2. Installation

2.1 Installation Prerequisites

It is strongly recommend to have a minimum of two people performing installation of the solar panel, base, and pole.

Required Install Tools: 5mm & 6mm Allen keys for junction box (*included*), T40 torx key for solar panel (*included*), 10mm Allen key, 20mm hole saw, battery drill, phillips screwdriver, flat head screwdriver, lifting equipment, padlock with key, large adjustable spanner. A laptop with RJ45 network interface is **strongly** recommended for camera setup.

For more information and videos regarding base and pole installation, please visit the below website.

<https://help.c5k.info/solar-installation>



2.2 Installing the Optional Base

Warning: The pre-assembled base weighs approximately 500kg. Specialist lifting equipment is required to move the base. Care must be taken to prevent injury when moving the base.

Pre-Assembled Base:

1. Locate a hard level surface to install the base, ensure that there is easy access for the lifting equipment that will be required, and that it is free from objects that will shade the solar panel, such as trees or buildings.
2. Using lifting equipment, position the base on the ground.

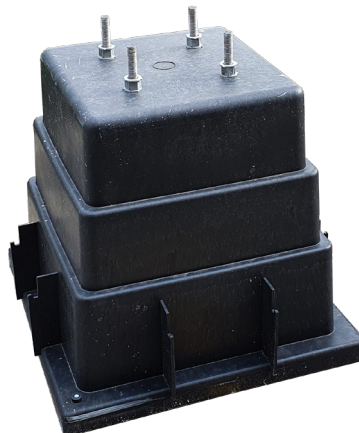

2.2 Installing the Optional Base (continued)

Un-Assembled Base:

1. Locate a hard level surface to install the base, ensure that it is free from objects that will shade the solar panel, such as trees or buildings.
2. Install the reinforcing cage inside the base. Install a washer and nut on each threaded rod on the top side of the base, to secure the cage. (Fig. 2.2a)

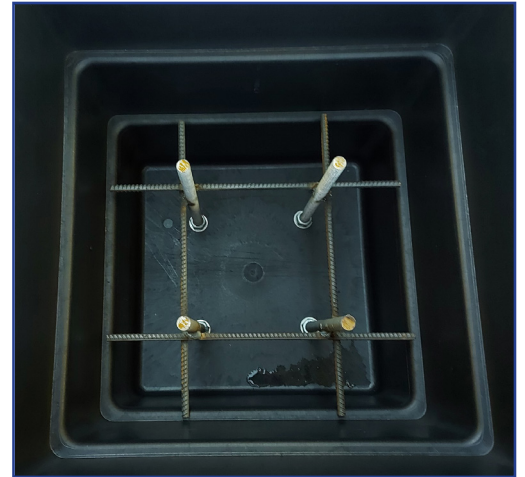

Fig. 2.2a
Cage installed

3. Place the base open side up, on top of a solid object such as concrete besser blocks. (Fig. 2.2b)

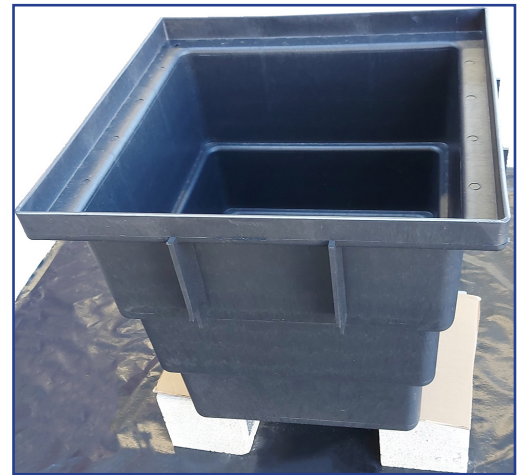

Fig. 2.2b
Base on blocks

4. Mix approx 480kg of concrete, and pour into base. Ensure the concrete that is exposed is level with the top of the base, otherwise the base will not sit level on the ground. (Fig. 2.2c)
5. Allow a minimum of 7 days for the concrete to cure, this can take longer depending on weather conditions.
6. Once the concrete has cured, use suitable lifting equipment to turn the base over



Fig. 2.2c
Concrete curing

2.3 Installing the Optional Tilt Pole

Warning: The tilt pole weighs approximately 100kg. Care must be taken to prevent injury when installing the pole.

1. Attach a lifting sling to the hinged part of the pole.
2. Unhinge the pole and position the pole base over the 4 threaded studs.



Fig. 2.3a
Mounting pole onto concrete base



Fig. 2.3b
Pole fixed onto on concrete base

3. Install the included washers and nuts. Ensure the nuts are fastened securely.
4. Refer to *Section 2.4 - 2.8* to mount the camera and solar panel to the pole. After the steps have been followed continue with the steps below.
5. Using lifting equipment, raise the pole.
6. Once the pole is vertical, secure it into position with the included bolt and nut.
7. Using a padlock, lock the pole.
8. Re-tighten the nuts on the pole base.

2.4 Mounting the Solar Panel to the Pole

Caution: Solar panel **must** be placed so it is in **direct sunlight all day**.

Any shading will greatly reduce the solar panel's performance.

1. Drill an 20mm hole in the pole (minimum 15cm down from the top of the pole) on the same side that the camera will be mounted.

This is for the solar panel cable and plug to run through. The position of the hole will vary depending on what position on the pole the camera is to be mounted. If using the optional tilt pole, this hole will be pre-drilled,

2. Feed the power cable and plug connected to your solar panel through the hole.
 3. Place the solar panel bracket on top of the pole, pointing north.
- **Note:** If you need to cover a different area with the light beam, keep the panel flat after repositioning.



Fig. 2.4a
Solar panel power cable hole location

4. Securely fasten the included grub screws to the bracket. Tighten the locking bolts to prevent the grub screws from loosening. (*Fig. 2.4b*)
- **Note:** For poles greater than 4m in height, tapered poles are preferable for camera stability and pole strength.

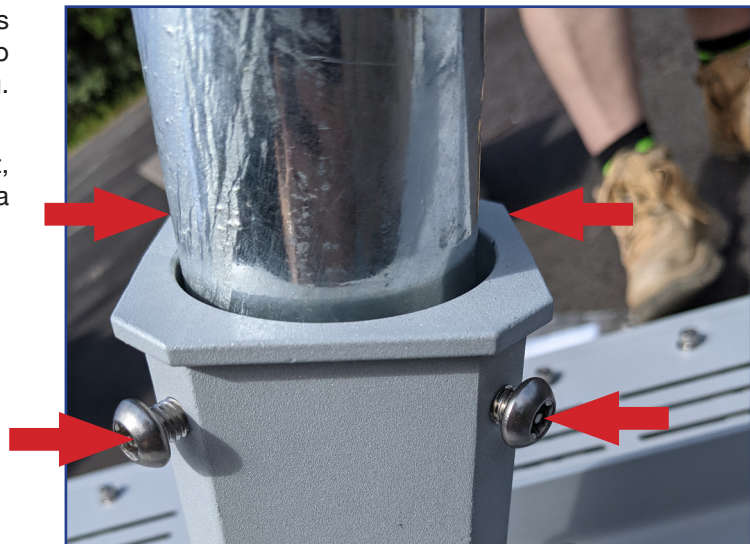

Fig. 2.4b
Installed grub screws

2.5 Adjusting the Solar Panel Angle

To ensure your solar panel absorbs as much light as possible, it's important to adjust the solar panel angle.

For Australia and all locations in the southern hemisphere, the lower edge of the solar panel must point north. Locations in the northern hemisphere must have the lower edge of the panel pointing south.

The angle of tilt should ideally be 10° North. If you are using the light on the solar panel, keep in mind which direction this will face, and adjust accordingly.

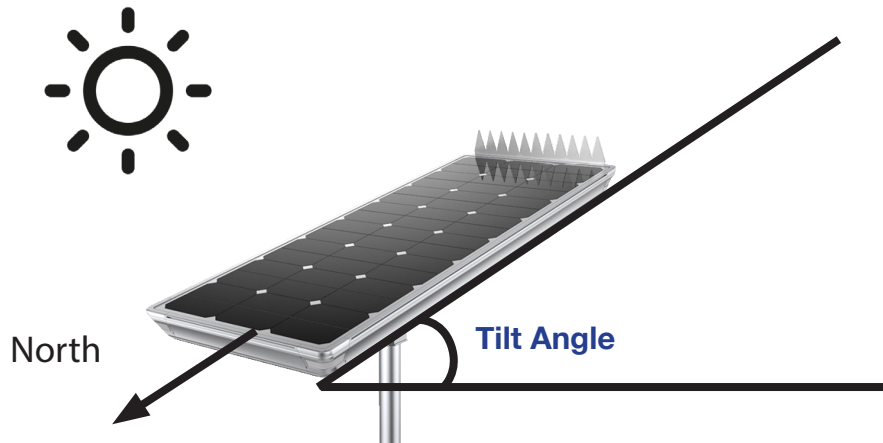

How to adjust tilt angle:

1. Use a flat head screwdriver to remove the bracket cover (Fig. 2.5a).
2. Once the cover is removed, use a 10mm Allen key to loosen the panel adjustment bolt and tilt the panel to the required angle with the LED light at the high side. (Fig. 2.5b).
3. Tighten the bolt after adjusting the angle to secure the solar panel in place.
4. Replace the cover.



Fig. 2.5a
Solar panel angle
screw cover

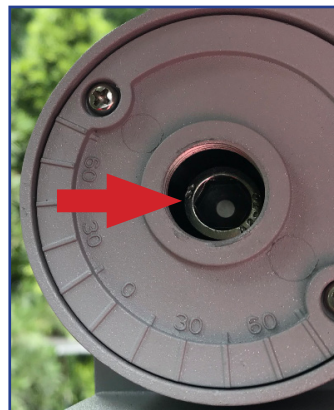

Fig. 2.5b
Solar panel angle
adjustment screw

2.6 Camera Mounting & Wiring

1. Open the junction box by loosening the 4 screws, and loosen the 2 screws (*Fig. 2.6a*), holding on the junction box mounting plate and pole bracket (*Fig. 2.6b*).
2. Mount the junction box mounting plate and pole bracket onto the pole using 3 included band clamps (*Fig. 2.6c*).

Note: The 3 included band clamps are 65-89mm for poles 50-60mm in diameter. If installing on a thicker pole (eg. 80-150mm), larger band clamps will be required.



Fig. 2.5a
Mounted pole bracket (front)



Fig. 2.5b
Mounted pole bracket (front)



Fig. 2.5c
Mounted pole bracket (back)

2.7 Camera Mounting & Wiring (continued)

3. Reinstall the junction box to the junction box mounting plate, and securely fasten the 2 screws. Leave the junction box open.
4. If using a 4G solar kit, insert an active Micro SIM card into the SIM card slot in the modem. (Fig 2.7a)
If using a Wi-Fi solar kit, mount the wireless antenna to the pole with the included mounting hardware, and attach the ethernet cable. (Fig 2.7b)



Fig. 2.7a
4G router overview



Fig. 2.7b
Wifi antenna mounted

5. Attach the waterproof plug from the solar panel side, to the camera side.
6. Close the junction box and securely fasten the 4 bolts (Fig. 2.7c).



Fig. 2.7c
Camera and junction box

2.8 Reconnect Battery

The Solar Light is shipped with the battery disconnected from the system.

To activate the Solar Light, this battery must first be reconnected. To reconnect:

1. Remove the “Battery Disconnected” sticker. (Fig 2.8a)
2. Find the two cables labeled “Battery”. (Fig 2.8b)
3. Taking note of the cable key, connect the two cables. (Fig 2.8c)
4. Twist the waterproof locking connector until tight. (Fig 2.8d)
5. Install the solar panel connection cover, included in the solar panel accessory bag. (Fig 2.8e)

Once the battery is connected, a red LED will flash slowly inside the black sensor on the solar panel. If the battery is connected correctly and this does not occur, this likely indicates low battery voltage - place the system in direct sunlight for at least 1 hour to charge before continuing.



Fig. 2.8a



Fig. 2.8b



Fig. 2.8c



Fig. 2.8d

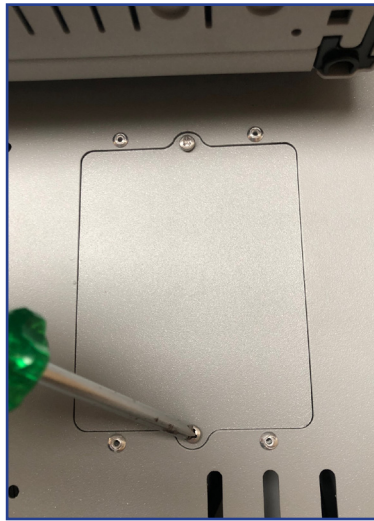

Fig. 2.8e

3. Wi-Fi (Applies to SLR-B120/180-4W Only)

3.1 Connect using WiFi

This section covers how to set up the Access Point side of WiFi network for your WiFi Solar Surveillance Kit. **Note:** The station side of the wireless bridge should already be mounted under the solar panel.

1. Ensure the Ethernet cable is connected between the camera and the wireless bridge (station), as per section 2.6.
2. Mount the other side of the wireless bridge (access point) on the building, facing towards the station on the solar panel.
3. The access point can be powered by connecting the AP's network port to the included PoE injector, then connect the injector to a network switch and power supply.
4. (Optional) Connect the network switch to an NVR (The camera includes a microSD card for edge recording).
5. (Optional) Connect the network switch to a router, to be able to remotely access the NVR.



4. Camera Remote Access

4.1 QR Code Remote Access Setup (4G)

Internet access is required for remote access setup.

1. Install the free mobile application (**DMSS**) from the App Store for iOS or Play Store for Android.
2. Open the **DMSS** app you have installed on your device and select the “+” icon
3. Select **SN/Scan**. (Fig. 4.1a)
4. Use your mobile device to scan the **QR code** (refer to configuration sheet inside junction box). (Fig. 4.1b) Make sure the app is permitted to access your phone’s camera. Alternatively, select **Manually Enter SN** and enter the serial number of the camera.
5. Select **Wired Camera**. (Fig 4.1c)
6. Enter a **Device Name** for the camera. This name is for reference only.
7. Enter the default username **admin** and password (refer to configuration sheet inside junction box). For extra security, be sure to change these details before completing installation.
8. Select **Save** (Fig. 4.1d), if the details are correct, the camera will display a live image

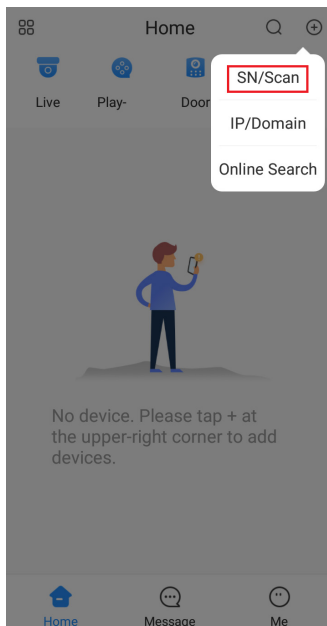

Fig. 4.1a
Main Menu



Fig. 4.1b
Camera details

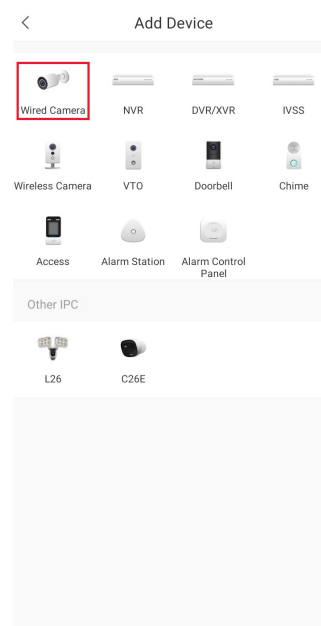

Fig. 4.1c
Device Type

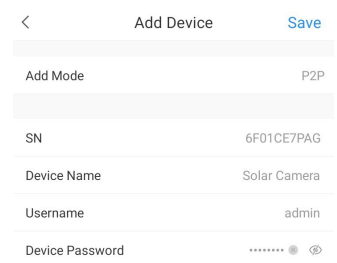

Fig. 4.1d
Camera Details

4.2 Adjusting Stream Settings

You can choose between using Main or Sub stream when Live Viewing on the mobile application. (Fig. 3.2d) Main displays a higher quality stream but uses up more data and can take longer to load, while Sub consumes less data and bandwidth but has lower image quality. When using Playback, ensure that Playback is set to Main. If set to Extra, the screen will be black. This is because the camera has been preset to only record the Main stream to the microSD card.

1. Open the application and go the home screen and select the 3 dots “...” next to the device. (Fig 4.2a)
2. Select **Device Details** (Fig 4.2b), then **Stream Settings**. (Fig 4.2c)
3. Adjust the stream settings, Set **Live** to **Sub**, and **Playback** to **Main**. (Fig 4.2d)

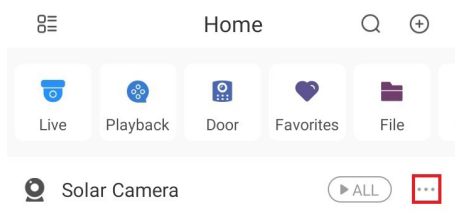

Fig. 4.2a
Home Screen

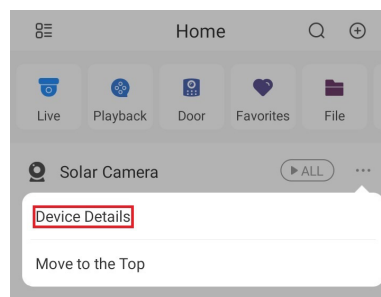

Fig. 4.2b
Device Details

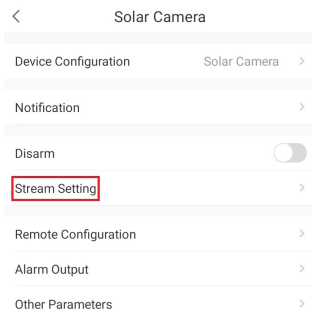

Fig. 4.2c
Device Details

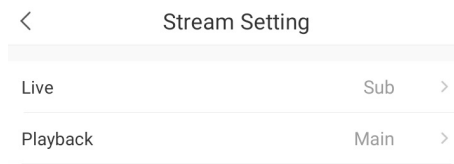

Fig. 4.2d
Stream Settings

4.3 Additional Camera Configuration

For more information regarding camera setup and use, please visit:

<https://help.c5k.info/solar-camera-setup>



5. Solar Panel, Sensor & Light Configuration

5.1 Solar Sensor Light Introduction

This section covers how to set up the motion-activated 50W (SLR-B120) or 60W (SLR-B180) LED light on the solar panel. Our example will show you how to configure your solar panel & light with the remote control, showing you how to configure the light to activate after motion is detected at night.

Warning: Modification to the LED light and sensor default values may increase power consumption, affect light uptime and more.

Incorrectly editing settings can permanently damage the solar panel, battery and/or LED light. Performing changes to contrary to those in this guide may cause damage to the panel not covered under warranty.

All configuration of the solar panel & LED street light is performed with the included infrared remote. The remote interacts with the panel's infrared receiver to control settings (the dark circle on the underside of the panel). Any modification to settings is best performed at night, as infrared interference during the day may reduce remote range.

The remote control allows you to adjust solar panel, battery & sensor settings and then transmit them to apply the configuration to the solar system. See initial menu options and button functions below:

Startup Menu Options

SystemInfo	Diagnostic tool to check performance of solar system including uptime, battery & panel statistics.
Alert	Not applicable.
SysConfig	Configuration interface where new settings are set & transmitted to the solar system.
Local	Language and device name settings. Do not change device name from PCC_G05.

Remote Control Button Functions



Fig. 5.1a
Solar panel remote
control & LCD

	Power	Press to power on. Press and hold for 2 seconds, then release to power off the remote control.
	Scroll Up	Press to scroll up.
	Scroll Down	Press to scroll down.
	Controller On	Press and hold to enable the LED light control.
	Controller Off	Press and hold to disable the LED light control.
	Enter	Press to select item or confirm changes.
	Back	Press to select item or confirm changes.
	Transmit	Press to transmit parameters to the control board.
	Test	Press to test the LED light.

5.2 Settings Detail

Each Solar Light has default factory settings for light configuration and battery configuration. Below are the functions of each setting in the **SysConfig** menu and the solar system default settings. Before adjusting solar panel and light settings, familiarise yourself with the setting definitions below.



Note: Modification to the LED light and sensor will increase power consumption and reduce battery power available for the system.

Incorrectly editing settings can permanently damage the solar panel, battery and/or LED light. Only edit power settings exactly as outlined in this guide. Please contact your place of purchase for more information.







Name	Remote Title	Description	Settings	Default Settings
Battery Type	Bat Type	Type of battery installed in the solar panel	Li_Po / Lead_acid	Must use Li_Po for LiFePO4 battery, DO NOT change this parameter
Boost Charge	BoostCharge	Battery overcharge voltage. To protect the battery from overcharging, the battery stops charging when it is above this voltage.	10.80V ~ 32.80V	SLR-B120: 14.4V SLR-B180: 28.8V Warning: Changing this setting may damage the solar system.
Voltage Low	Voltage Low	Battery cut-off voltage. When the battery voltage falls below this value, output will be disabled.	8.10V ~ 24.00V	SLR-B120: 10.5V SLR-B180: 21.0V Warning: Changing this setting may damage the solar system.
Recover Voltage	Recover Vol	Minimum voltage for the battery to start. Battery output is enabled or resumed from cut-off when battery voltage is above this value.	9.00V ~ 25.00V	SLR-B120: 12.0V SLR-B180: 24.0V Warning: Changing this setting may damage the solar system.
Power Saving	PowerSaving	When turned on, the battery will adjust power output automatically to save energy.	On / Off	All Models: Off
Turn-On Photovoltaic Voltage	TurnOnPVVol	The solar panel acts as an ambient light sensor. Once the solar panel voltage drops below the 'Turn-on PV Voltage', the light turns on.	4.0V ~ 12.0V	All Models: 5.0V
Output Current	Output Cur	Set the constant current output level.	150mA ~ 4000mA	All Models: 300mA
Drive Mode	DriveMode	Time Control: Set up to 5 periods of up to 9 hours each, controls light activation. Time intervals begin after TurnOnPVVol threshold is reached i.e: the sun has set. Light brightness in each period is set by Light Ratio . Move Sensor: Adds motion detection on top of 5 time periods. The light abides by Time Control , but dims to Idle Ratio and brightens to Light Ratio based on movement detection.	Time Ctrl / Move Sensor	All Models: First Period: 2 Hours Second Period: 3 Hours Third Period: 7 Hours Fourth & Fifth Periods: Not Set
Light Delay	LightDelay	Countdown timer after last detection motion where light output stays at Light Ratio setting before switching to Idle Ratio setting.	0s ~ 120s	All Models: 30 seconds.
First, Second, Third, Fourth, Fifth Time		User-programmable light on/off schedule. Maximum 9 hours for each setting.	0.00hrs ~ 9.00hrs	Sets time periods, see Drive Mode for default settings.
Light Ratio	LightRatio	Set light output (%) for Time Control or when movement is detected in Move Sensor mode.	0% ~ 100%	All Models: First Period: 100% Second Period: 60% Third Period: 30% Fourth & Fifth Periods: Not Set
Idle Ratio	Idle Ratio	Set light output (%) in Move Sensor mode after last detected movement and after Light Delay elapses.	0% ~ 100%	All Models: First Period: 30% Second Period: 20% Third Period: 10% Fourth & Fifth Periods: Not Set
Morning Light	MorningLight	Overrides TurnOnPVVol , making the light stay on during the day, as per the Drive Mode Time Control parameters.	On / Off	All Models: Off

5.3 Activate LED Light

Before activating the LED light system, the internal battery will require power. Place the solar panel outside and wait for it to charge in the sunlight for at least **one hour** before continuing.

1. Follow **4. Quick Solar Light Configuration** to enable the solar light.
 2. Use the remote control and point it towards the black sensor at the back of the solar panel and press  **Power**. The remote control will be powered up. It will then try to connect the solar panel.
 - If connection is successful, the LCD will show “Read OK”.
 - If connection fails, the LCD will show “Disconnect”
Note: Direct sunlight can interfere with the transmission. The sensitivity of the transmitter is higher when in dark environment.
- Important:** Do not change the device number unless you have no communication to the remote. It is located in the Local settings menu.
The device number for will be either **PCC_G05** or **PCC_G04**, depending on the model of solar panel.
3. Press and hold the  **ON** button to enable the solar light.

5.4 Change LED Light Settings

1. Point the remote control at the solar panel's black sensor and scroll to the SysConfig (System Configure) and press  (Enter) to enter the system configuration menu.
 - Use  and  to scroll.
 - Press  **Enter** to begin editing values. The value will be shown in reverse colour.
 - Use  and  to change the value.
 - Press  **Enter** again to confirm.

Note: The remote will power off automatically if no key is pressed for 3 minutes.

Five periods of time can be set to turn on the solar panel LED light. These periods can be set with a min. of 0 and max. of 9 hours. (9 hours by default - refer to 5.2 Default Light Ratio & Period Settings)

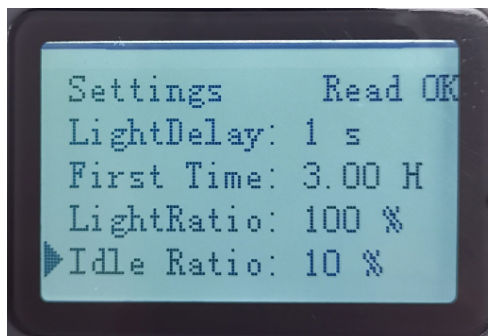

*Fig. 5.4a
Motion activated light settings*

2. Point the remote control at the solar panel's black sensor and press  **Transmit** to update the solar panel with your new configuration. If you hear a long beep, the configuration settings are transmitted successfully.

5.5 Disable LED Light

To disable the LED light system again, simply change the **Drive Mode** from **Move Sensor** to **Time Ctrl**. This will skip every Interval after the sun sets, so editing other values after this point is unnecessary.

5.6 Check Solar Panel On/Off Duration

To check the solar panel's current settings configuration, scroll to the SysConfig menu and press  **Enter**. This will show info such as photovoltaic voltage, battery voltage, output voltage, current and power, temperature and total operating time in minutes and more.

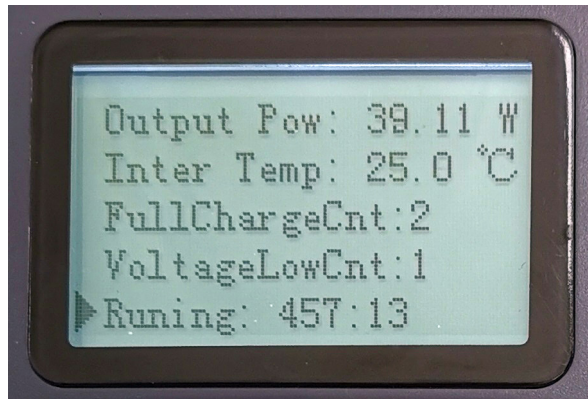
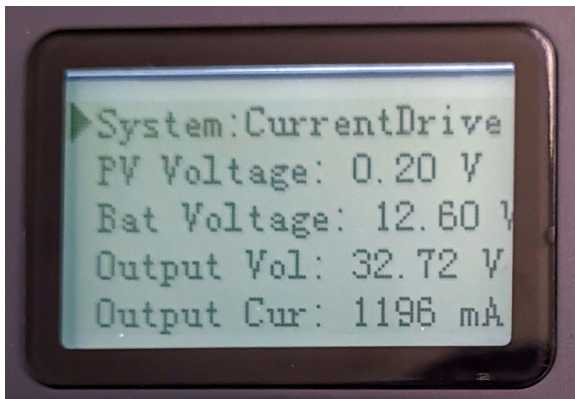

Fig. 5.6a / Fig. 5.6b
Solar panel power settings & information

5.7 Test LED Light

1. Point the remote control at the solar panel's black sensor and press Test.
2. Test the LED light by adjusting the light level on the remote screen with the Test button. This scrolls through different light percentages. (100%, 70%, 50%, 30% and 0%)

5.8 Lock/Unlock the Remote Control

After setup has been completed, you can lock the remote control to prevent settings from being accidentally changed, or changed by somebody else.

To Lock/Unlock the remote control, press the  **Test**,  **Enter** and  **Back** buttons together.

If you hear a single beep, the remote is now locked. If you hear three beeps, the remote is now unlocked.

6. Troubleshooting

Problem	Troubleshooting
Cannot connect to camera remotely	<ul style="list-style-type: none">• Ensure a SIM card is installed that is activated, and has data remaining on it. (4G Models)• Ensure solar panel is charged, and there is power to the modem and camera
Camera only recording during daylight hours	<ul style="list-style-type: none">• Check camera schedule settings• Ensure solar panel charge settings are correct• Ensure there is no objects shading the solar panel, such as trees• Ensure the solar panel is clean
No communication to solar panel remote control Send failed from solar panel remote control	<ul style="list-style-type: none">• Move remote closer to solar panel sensor• Ensure the device number on the remote is set correctly, it will be either PCC_G05 or PCC_G04, depending on the model of panel.
Camera login details incorrect	<ul style="list-style-type: none">• Contact your supplier for assistance
Unable to playback footage	<ul style="list-style-type: none">• Ensure that the playback type is set to Main. (Section 4.2)• Ensure the recording schedule is setup correctly• Ensure an SD card is installed in the camera, by checking with Smart PSS



Version: VIPSLRB-Q121

Note:

All products, designs and software here are subject to change without prior written notice.