

LFL-C50-CS2 LED Floodlight Installation Manual

Notes before installation:

- Please read LED Flood light use manual carefully before installation and follow the instructions.
- To avoid accidents like damage, dropping, electric shock, fire, please don't arbitrarily retrofit or change any lamp fittings. Clean lamps with a soft wrung-out soapy cloth, and then wipe it with a dry cloth. Please don't wipe the lamps with gasoline or other volatiles. Please don't spray insecticides on the lamps. Otherwise, it may cause discoloration or damage. Please do not open the lamp without permission.
- Please turn off the power when in installation or maintenance.

1.1 Installation & Dimensions(Unit: mm)



LFL-C50-CS2

Mounting diagram (Figure B)

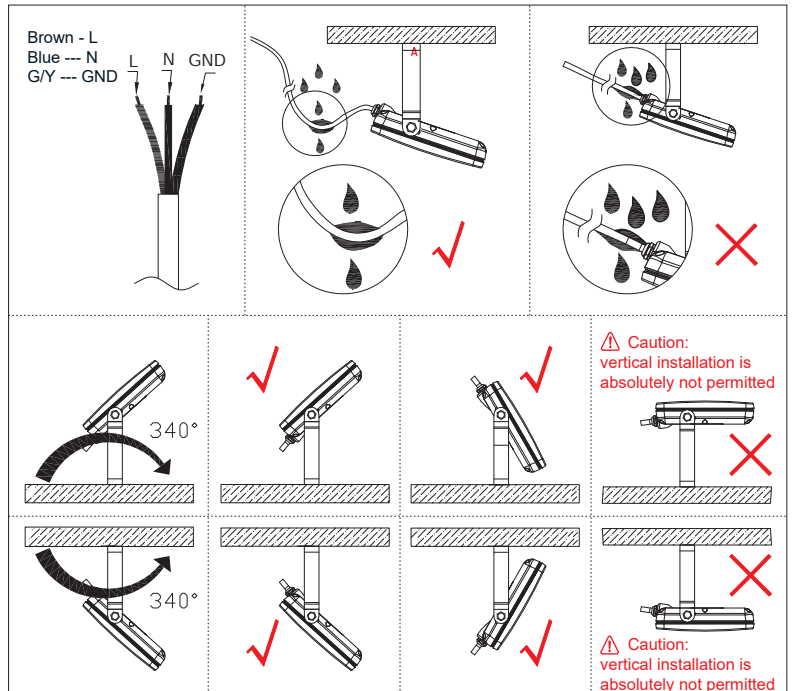
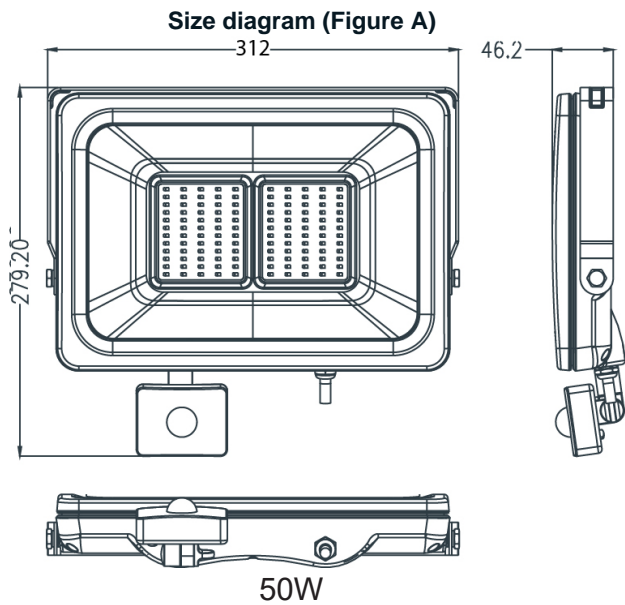

Please installation follow below way:

Installation Instructions

1. Mount the LFL-C50-CS2 Flood light onto a surface, wall or ceiling by adjusting the attached U-Shape bracket (0 ~ 180°).
2. Rotate the flood light (0 ~ 340°) in the direction most suitable for the lighting installation. Do not mount the flood light vertically up or vertically down (refer to Figure B).
3. Connect the power cable to a 100~240VAC power supply.
4. Ambient Sensor: Turn the dial +/- to adjust the lux level sensitivity from 2 ~2000lx (refer to Figure C).
5. PIR Sensor: turn the dial +/- to adjust the passive infrared sensitivity from 2 ~6m radius (refer to Figure C).
6. On-time delay: turn the dial +/- to adjust the time the light stays on from 5s ~ 5mins before switching off (refer to Figure C).

PIR Motion Sensor (Figure C)

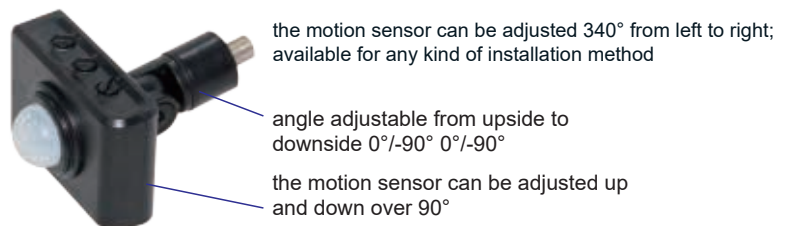
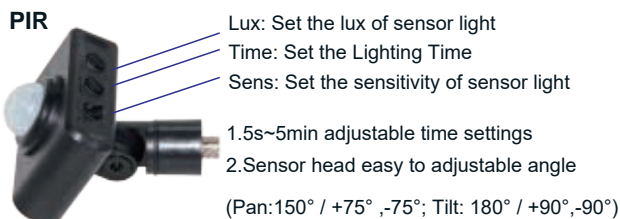

PIR Motion Sensor Rotation (Figure D)

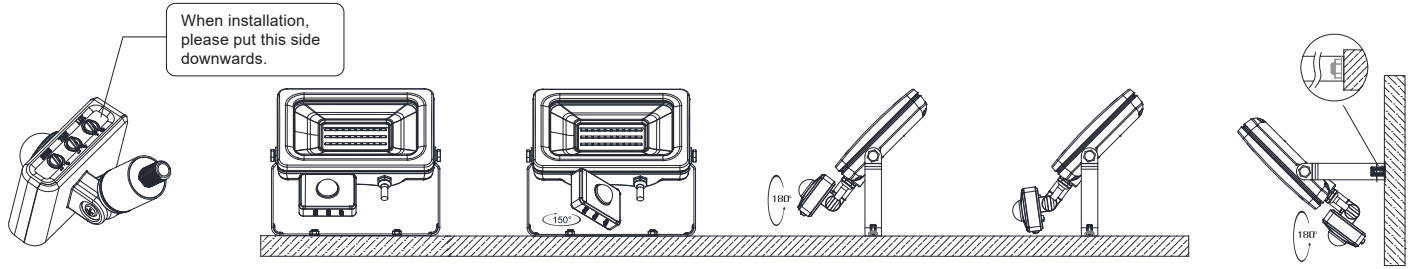

1.2 Motion Sensor Diagram

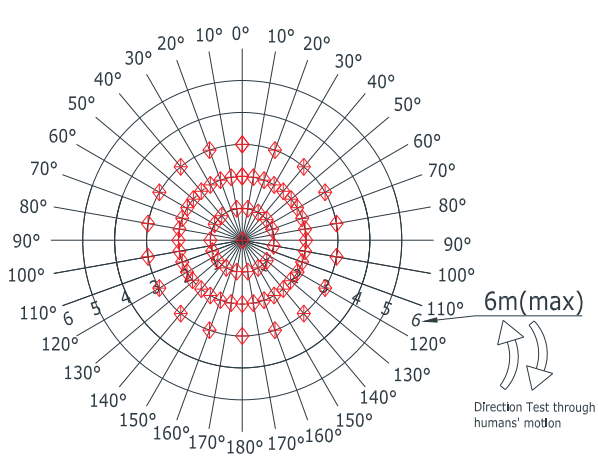

Hanging Installation Motion Sensor Sketch:
range: 360°*6m(max)

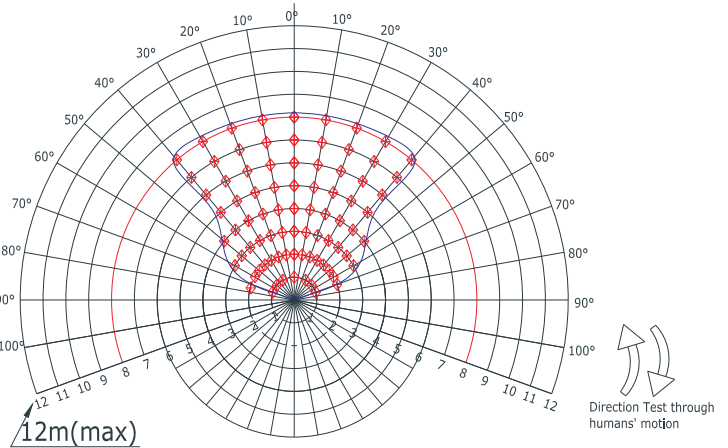

Horizontal Direction Motion Sensor Sketch
range: 140°*12m(max)

Since the PIR sensor can sense surrounding changes of brightness and temperature, like in places below, it may cause mis-operation or non-operation.

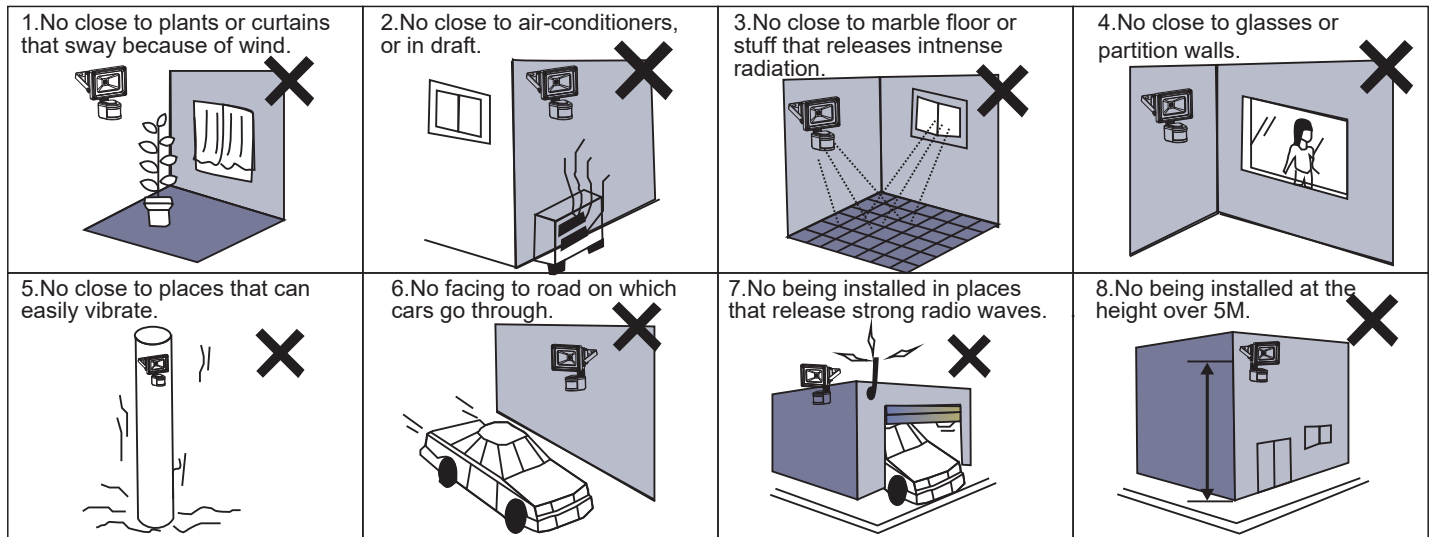

1.5 Attention

1. Install by qualified electricians only.
2. Make sure that the supply voltage is disconnected before installation.
3. Make sure the voltage is suitable with the lamps, And L/N/G connect properly.
4. All the lights during installation or using should not be led's cover vertical upside or Vertical down.
5. Don't open the lamps without Manufacturer's Authorization.