

Read before installation

- If **ONLY** RED LED stays on (no flashing), the device is under OTA (Off-the-air) firmware upgrade. Please DO NOT power off and wait patiently. It may take about 5 minutes. The device will reboot automatically after firmware upgrade.
- Make sure the SIM card and Micro SD card is inserted properly. Gold contacts face up, cut corner inside.



- SIM card and Micro SD card sockets are Push-in-Push-out type, do not use any tools to extract the card.
- Optus network is preferred. (Optus, Amaysim...etc)
- For safety reason, remote fuel cut-off cannot be activated when the car is moving.



3G/WiFi In-Vehicle Surveillance & GPS Tracking System Quick Start Guide

Thank you for purchasing the Securview Vehicle Surveillance & Tracking System
This Quick Start Guide covers basic setup, installation and use of your surveillance system.
For more information, please visit: www.securviewcctv.com

Included Components



Surveillance/GPS system & mounting cradle + Screwdriver



External backup battery

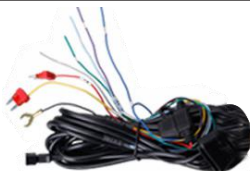

Power wiring harness



SOS alarm button



12V 40A relay & relay cable
*** Please contact us if you need 24V relay



2 x 3M adhesive mount

1. Overview & Installation

1.1 System Diagram

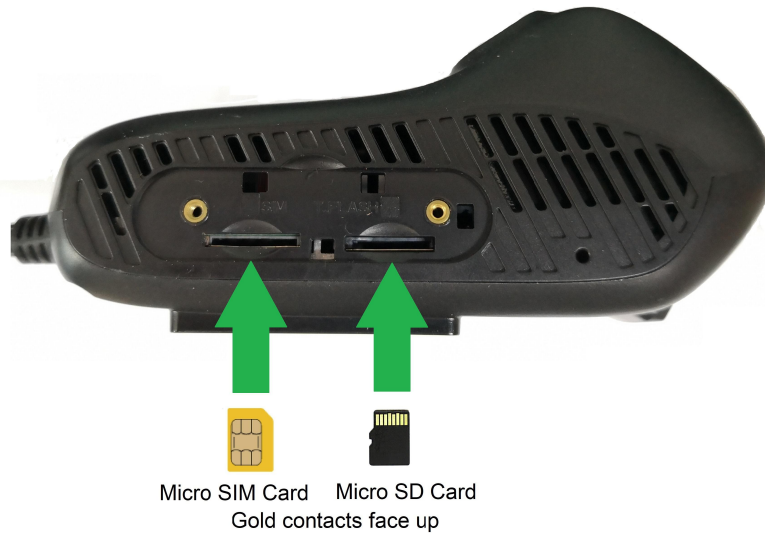
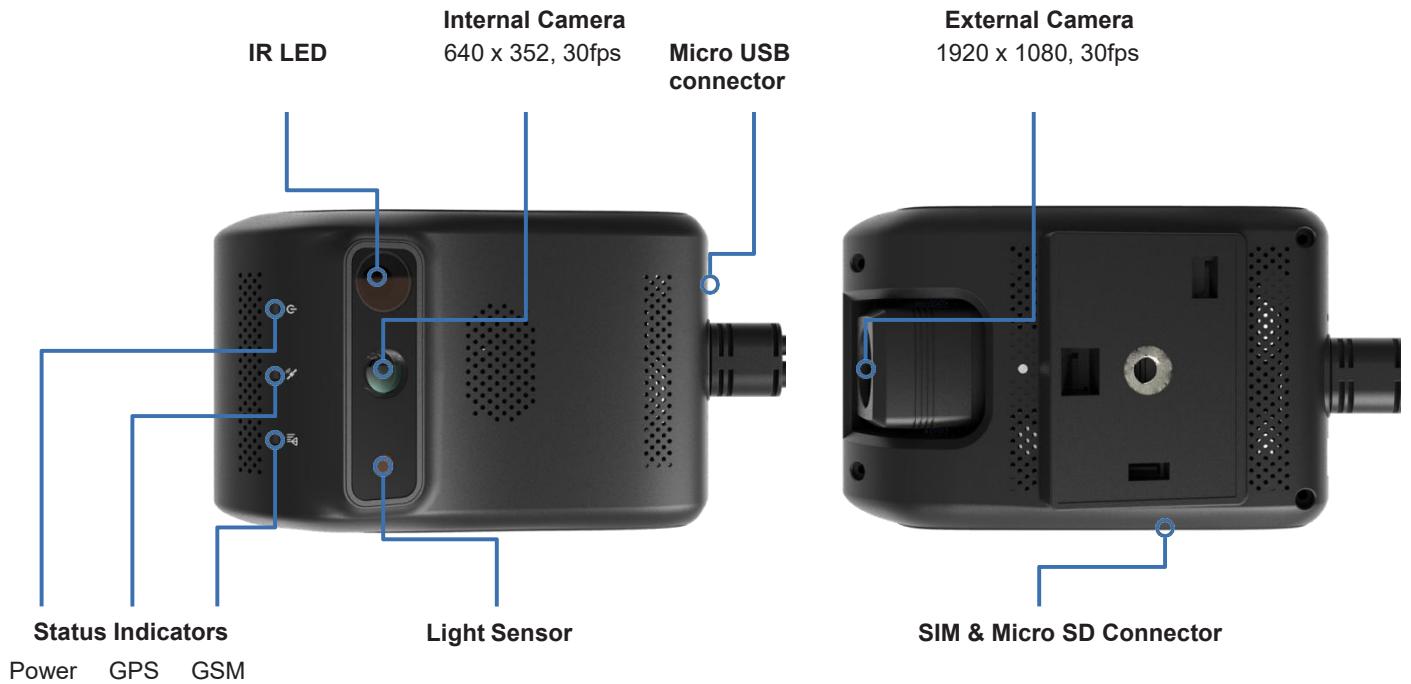

Warranty void if cards are inserted the wrong way

The SIM card and Micro SD card sockets are Push-in-Push-out type. Do not use any tools to extract the card.

1.2 Technical Specifications

	Model	MDVR- J200
Camera	Camera Style	Mobile Dual Lens Camera, infrared driver facing lens
	Resolution	Road facing: 1080p (1920 x 1080) / Driver facing: (640 x 352)
	Angle of View	Front: 140° (adjustable) / Rear: 90°
	Focus	Fixed
	Frame Rate	30fps
Features	CPU	ARM Cortex A7 Quad Core 1.2GHz
	Band	GSM 850/900/1800/1900 WCDMA 850/900/1900/2100
	G-Sensor	9 axis-motion
	Live View	In-car / front car live video via app or web
	Audio	Built-in speaker & microphone
	WiFi	Frequency 2.4GHz, hot spot
	Bluetooth	BT4.0 (Android platform only)
	Micro SD storage	Max. 32GB(FAT32 format)
	Battery	External 450mAh
	Audio	Built-in microphone / Built-in speaker
Interface	OBD Interface	Connect by power cable
	USB Data Interface (Engineering Purpose Only)	Micro USB 5 Pin Not for data backup
	Housing	Plastic
	Power Input	12 - 24VDC
	Dimensions	109 x 69 x 52mm
	Weight	0.23kg
	Operating Environment	-20° to 75°C / RH95% (max)

1.3 Installation

1.3.1 Wiring

Connect cables according to the wiring diagram 1.3.2. Connect the power cable B+ (Red wire) and GND (Black wire) to the vehicle battery's +12V/+24V terminal and negative terminal respectively. Connect ACC (Yellow wire) to the vehicle's ON position. The device should power on automatically after the vehicle engine is started.

Remember to connect the backup battery module.

1.3.2 Wiring Diagram

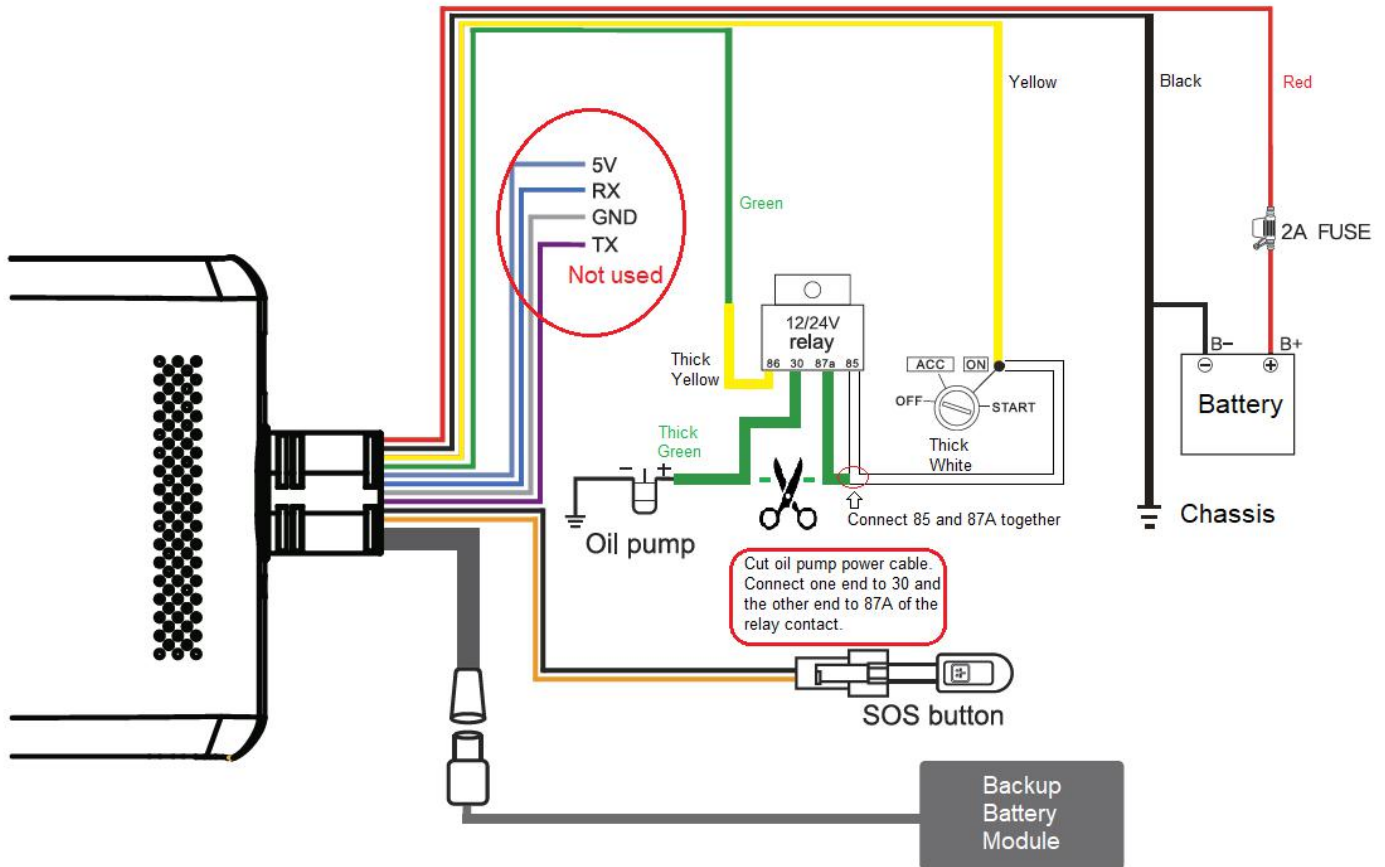

1.3.3 Micro SD and SIM Card

While the system is off, insert the Micro SD card into Micro SD slot and an active SIM card into the SIM slot (both located on one side of the camera).

After inserting both cards, screw on the card cover with the provided screw & screwdriver.



1.3.4 Status Indicator Lights

Power Indicator - RED		
●	Solid red	ACC ON & Power on
⦿	0.1s ON & 10s OFF	ACC OFF
●	Off	Power not connected
GPS Indicator - GREEN		
●	Solid green	ACC ON & Positioning successful
⦿	0.1s ON & 1s OFF	Searching for GPS signal
●	Off	ACC OFF
GSM Indicator - BLUE		
●	Solid blue	ACC ON & Connected
⦿	0.1s ON & 1s OFF	ACC ON & No network/SIM card
●	Off	ACC OFF

Must Read Information for Installers

1.3.5 First time GPS positioning - Tricks to make positioning quicker

GPS positioning for the first time takes a bit longer time when the device is installed. It may take about 5-10 minutes. Follow the steps below to initialize the GPS for quicker positioning:

- 1) Switch ON the engine.
- 2) Wait until the Red, Green and Blue LEDs on the device all stays on steadily (no flashing), that's mean the GPS and mobile signal are ready.
- 3) Turn OFF the engine and wait for 5 seconds.
- 4) Switch ON the engine again.
- 5) The new position should be updated when all LEDs are all on steadily.

Note: If the power of the device is disconnected and the device is moved to another new location when the device is off, always do the initialization steps above.

1.3.6 Choosing the right mobile phone card

- 1) Must use Micro SIM or Nano SIM with Micro SIM adaptor.
- 2) Must use 4G SIM cards (4G+3G). Don't use 3G SIM cards (3G+2G).
- 3) Must have **data, voice, and SMS** capabilities.
- 4) Must be able to monitor the usage, check the balance and recharge remotely by App or web site.

1.3.7 Car status update

All driving data and car status are uploaded to the web server, there is some delay between the car status on the web server and real situation. For example, when the car switches its engine ON/OFF, its on/off status will be updated on the web server within 3 minutes.

1.3.8 Vibration sensor sensitive

Vibration is inevitable during driving. For example, poor road conditions, humps and unintended shock on the device itself... If the Vibration Alert triggers frequently, you may adjust the sensitivity of the vibration sensor on the App. If this features is not need, you can also turn it off.

To enable/disable vibration alert, select "Vibration Alert" in Setting menu.

To adjust vibration sensitivity:

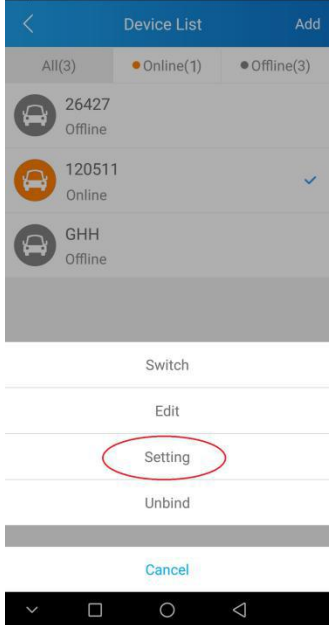
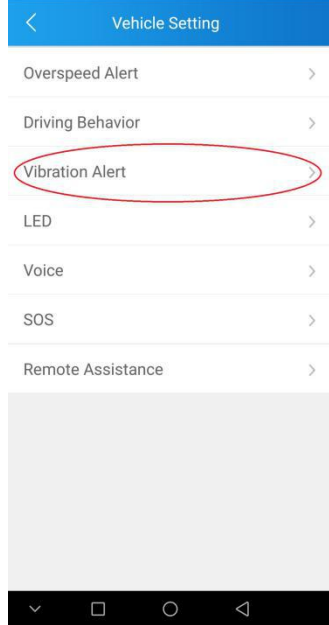
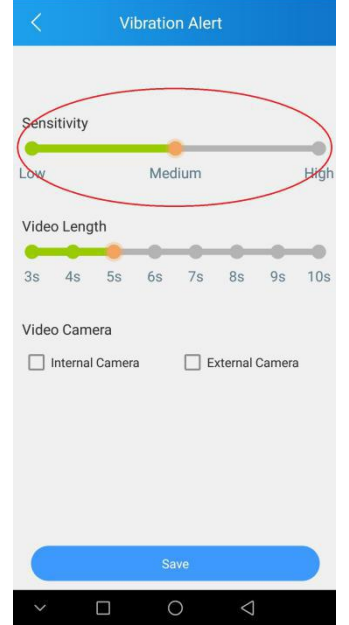
		
<p>Click the Device List and select the vehicle to set. Then click "Setting".</p>	<p>Select "Vibration Albert"</p>	<p>Slide the slide bar to adjust and click "Save" when finish.</p>

1.3.9 SOS button

SOS button will activate only if the button is pressed and held down for **more than 3 seconds**. Must enable SOS in "Setting" menu.

2. Operation

2.1 Automatic & Event Recording



2.1.1 Automatic Recording

ACC ON - The system will power on and record automatically.

ACC OFF - The system is in sleep mode and will not record.

Recordings will be saved onto the micro SD card every 3 minutes, under the directories:

DVRMEDIA/CarRecorder/GENERAL (road camera)

DVRMEDIA/CarRecorder/USB (driver camera)

NOTE: When the Micro SD card is full, old footage on the card will be overwritten.

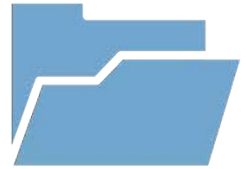

2.1.2 Event Recording

If a strong vibration is detected (from a crash, for example), an additional 15s will be recorded and then stored in a separate location under

DVRMEDIA/CarRecorder/EVENT

The EVENT folder stores 1GB of footage. Old recordings in EVENT will be overwritten when the folder is full.

2.2 System Usage

2.2.1 SIM Card Usage

This system is intended for use with a SIM card, but can still function as a mobile video recorder without one. Refer below to see what the system can do with and without a SIM card:

SIM Required

- Remote Live View
- Remote GPS Tracking
- Remote Picture/Video Capture
- Push Notifications (Geo-fence, vibration alert, etc.)

SIM Not Required

- Automatic Recording
- GPS History Logging
- Event History
- Media Synchronisation

2.2.2 App & Web Usage

The system can be accessed, monitored and configured via mobile app and web browser. Visit www.car-matrix.com for web version.

3. Configuration

3.1 App Introduction

Your vehicle monitoring system can be accessed, monitored and configured via mobile app.

Switch between cameras on your account on the phone.

3.1.1 App Intro

The vehicle tracking app **CarMatrix**, is available to download free from iPhone App Store and Google Play Store.

This app allows for portable vehicle management, letting you perform a variety of functions such as:

- Real-time GPS vehicle tracking & location reporting
- Real-time push notifications for overspeed, vibration, geo-fence etc.
- Geo-fencing - alerts when the vehicle enters/leaves a designated zone
- Route playback for vehicle history
- Remote live view, playback, image snapshot & video snapshot
- Media synchronisation for easy file transfers from recorder

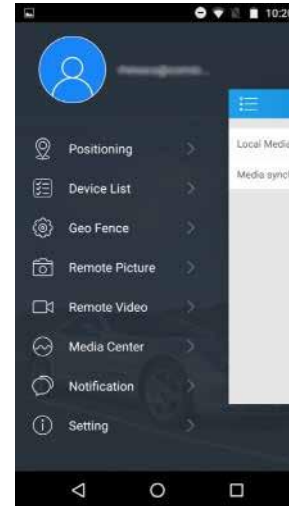

3.2 Account Registration

3.2.1 Account Creation

1. Press **Sign Up** on the front page of the app.
2. Enter your email address and press **Next** to send a verification code to your email address.
3. Enter the verification code into the app and press **Next** again to finish creating your account.

3.2.2 Change Password

- (App) Open the main menu and press the **user icon** next to your email address.
- (App) Press **Change Password**.
- Enter the current password, then enter your new password twice and press **Save**.

3.3 Binding Your Device to an Account

NOTE: After account registration, you will be automatically prompted to bind a device.

3.3.1 Adding Your Device

1. Open the main menu and press **Device List**.
2. Enter the 15-digit IMEI of your device which is printed on the box and on the top cover of the camera. **QR code scanning is under development and will be available in later version.**
3. Enter the number plate of the vehicle and a reference name for the device and press **Next**.

3.3.2 Unbinding Your Device

1. Open the main menu and press **Device List**.
2. Press the device you want to unbind, then press **Unbind**.
3. Press **OK** to confirm.

NOTE: MDVR-J200 cameras can only be bound to one mobile phone at a time. If you want to register the device on another mobile phone, you must unbind the device on the original mobile phone first.

3.3.3 Device Settings

1. Open the main menu and press **Device List**.
2. Press the device you want to unbind, then press **Settings**.
3. From here, you can edit the Overspeed Alert, Driving Behaviour, Vibration Alert, LED and Voice settings of your device.

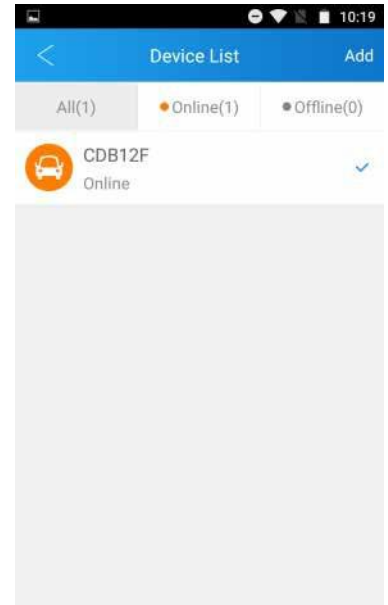

Device List



Settings menu

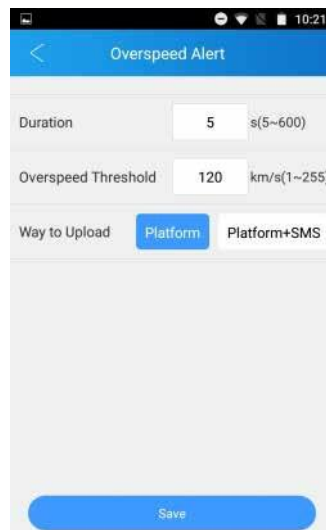

Overspeed Alert settings



Driving Behaviour settings

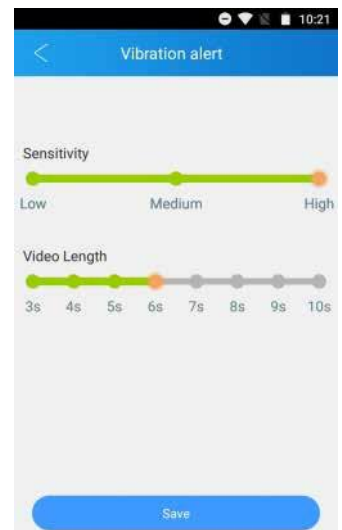

Vibration alert settings

3.4 Position, Track History & Live Tracking



GPS satellite view (App)

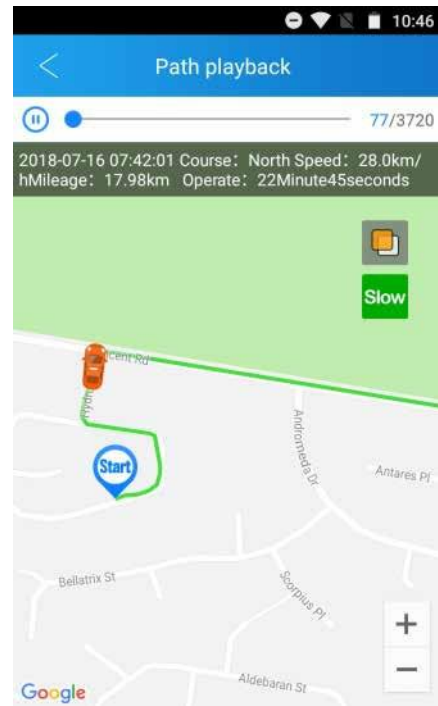

Path playback (App)

3.4.1 Positioning

1. Open the main menu and press **Positioning**.
2. This will display a live GPS display of your current vehicle location(s).
3. To view further details about a vehicle (including engine status, last time the vehicle was moved, IMEI and more), press the speech bubble above the car icon.

3.4.2 Track History & Path Playback

1. On the Positioning screen, press **Trips** at the bottom left.
2. This will open a list of previous trips the vehicle took, including start/end times and locations, as well as total distance travelled.
3. Press any of these trips for a detailed GPS map displaying the full route the vehicle took.
4. Use the slider at the top to skip to different parts of the playback. Map/satellite view and playback speed can be toggled with the buttons at the top right.

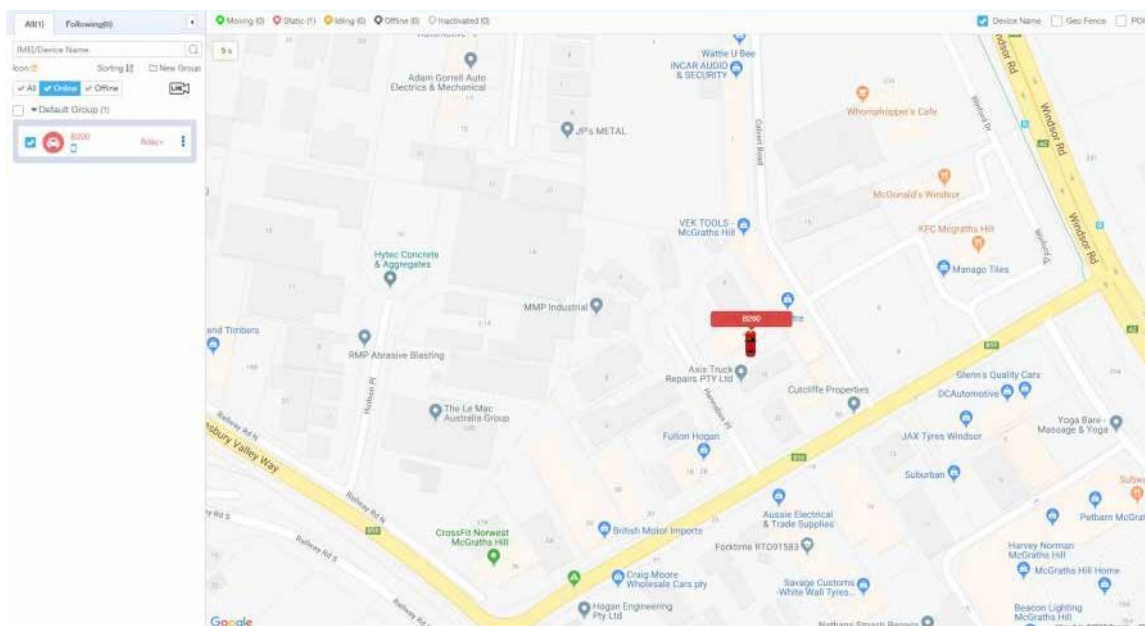

GPS tracking

3.5 Configuring Geo-fences

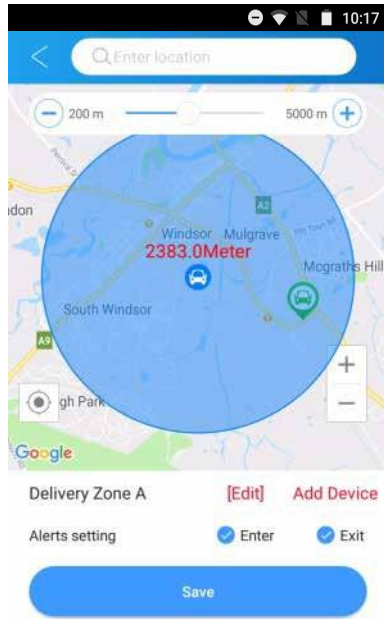

Creating a geo-fence (App)

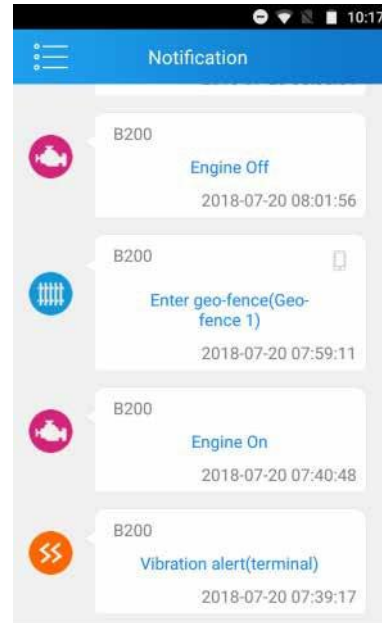

Geo-fence alert(App)

3.5.1 Geo-fence Intro

Geo-fences are GPS zones you can designate on a map. When your vehicle enters and/or exits the geo-fence, you can set the device to send a notification alert to your account.

3.5.2 Creating a Geo-fence

1. Open the main menu and press **Geo Fence**.
2. A list will appear showing all created geo-fences. Press **+** to make a new one.
3. A GPS map will appear. Navigate & place the geo-fence, then adjust its size using the slider.
4. After setting the geo-fence zone, press **[Edit]** to enter a name for the geo-fence.
5. Press **Add Device** and select the vehicle(s) you want the geo-fence to apply to.
6. Select one or both of the **Alert settings (Enter/Exit)**, to receive notifications on vehicle geo-fence enter/exit.
7. Press **Save** to confirm. You can edit the geo-fence from this menu at any time.

NOTE: Using the app, you can only create circular geo-fences. More precise geo-fences with individually drawn lines can be created from the website (www.car-matrix.com). Some features of the website are still under development. It will be more powerful in the later version.

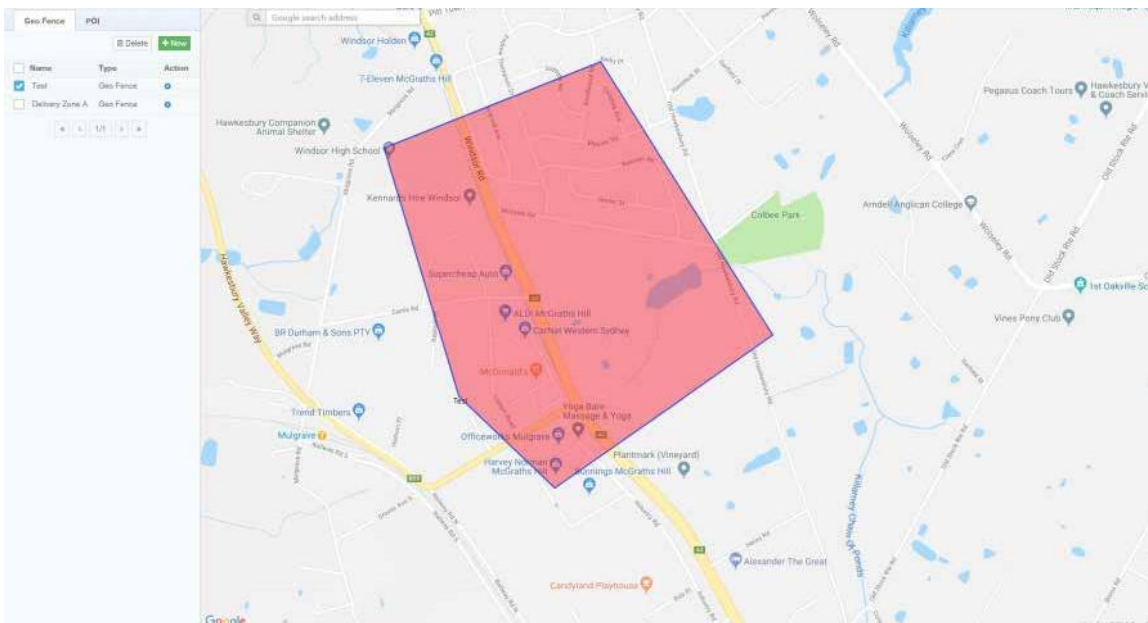

Creating a geo-fence

3.6 Camera Remote Access

3.6.1 Real-time Video Overview

1. Open the main menu and press **Remote Video**.
2. Press the **left camera icon** at the top right to enter start live viewing the camera in real time. This may take a few seconds to load, depending on your mobile network.
3. From here, several actions and options are available:
 - **Switch camera:** Press the camera icon at the top right (overlayed onto the video) to switch between the road and driver cameras.
 - **Playback:** Press the video screen to bring up a time bar. Scroll through to play recorded footage.
 - **Mute:** Mute/unmute the camera's microphone.
 - **Screenshot:** Saves a snapshot from the current camera display.
 - **Two-way talk:** Hold to talk through the camera with your phone.
 - **Record:** Record a clip from the camera display.
 - **Full screen:** Toggle portrait/landscape display modes.

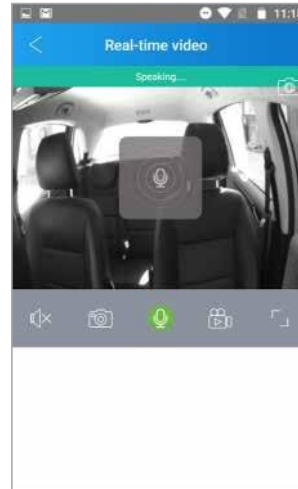

Two-way talk



Playback time bar

3.6.2 Remote Picture

1. Open the main menu and press **Remote Picture**.
2. In this menu, you can look through all snapshots taken from the camera. Click any of them to display them full-screen.
3. To save a snapshot to the camera, open an image and press **Save to album**.
4. To take a new snapshot, press the **camera icon** at the top right.
5. To share an image, press **Share** at the bottom right, then select the snapshot(s) to share and press **OK**.

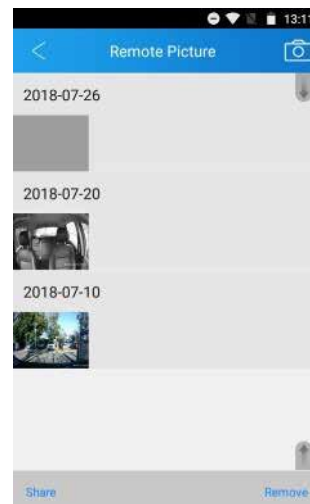

Remote Picture menu

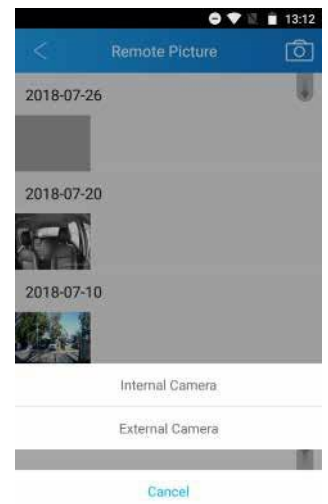

Taking a new picture

3.6.3 Remote Video

1. Open the main menu and press **Remote Video**.
2. In this menu, you can look through all video recordings taken from the camera. Click any of them to download, then click again to play.
3. To save a new recording, press the **right camera icon** at the top right. Select the **Internal or External Camera** to record and a length of time, then press **OK**.
4. To share an image, press **Share** at the bottom right, then select the videos) to share and press **OK**.

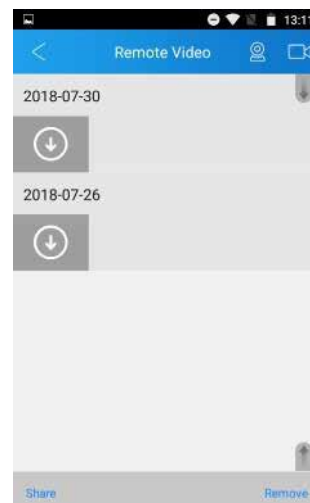

Remote Video menu

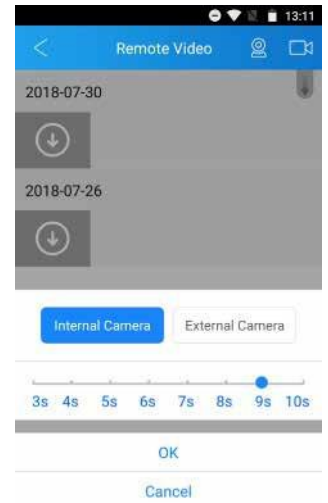

Capturing a video clip

3.7 Media Center & Backup

3.7.1 Local Media Library

1. Open the main menu and press **Media Center**.
2. Press **Local Media Library**.
3. In this menu, you can view, share or delete any saved snapshots & videos.

3.7.2 Backup via Media Sync

1. Connect the mobile to the camera's WiFi hotspot network. To connect, the camera must be powered on with the mobile nearby. Ensure that the blue GSM indicator on the camera is solid blue (not flashing).
2. Open the main menu and press **Media Center**.
3. Press **Media Sync**.
4. Select either **Photo** or **Video** to sync records of that type from the camera to the mobile.

NOTE: The username of the hot spot is the IMEI. The password is the last 8 digits of the IMEI. These can both be found on the camera.

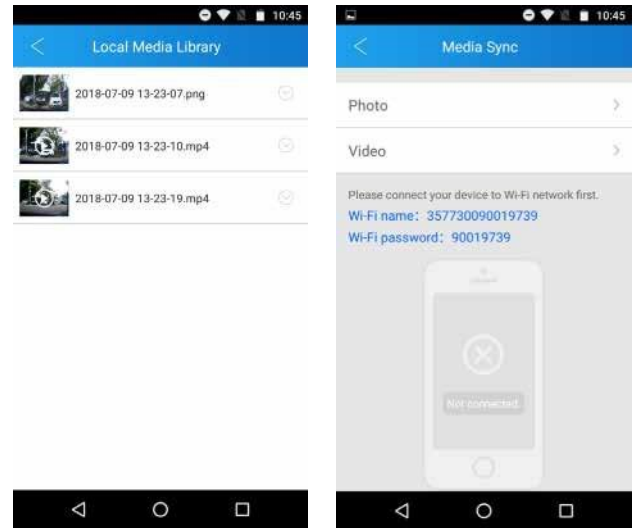

Local Media Library

Media Sync

3.7.3 Backup via Micro SD

Remove the Micro SD card from the camera. Insert the card into another device to directly copy saved records from it.

3.8 Notifications

3.8.1 Notification History

1. Open the main menu and press **Notifications**.
2. This menu will display a complete history of the device's notifications, including details on the time, date and type of notification. Scrolling to the bottom of the page will load older notifications.

3.8.2 Notification Events

The camera can alert the account of a wide list of events, which can be toggled on/off from the app.

- Collision / crash alert
- Vibration alert
- Enter / exit geo-fence alert
- Driver behaviour alert
- Engine on/off alert
- Overspeed alert
- Night driving alert
- GPS blind zone alert
- SOS alert
- Low battery alert
- Power off alert
- Disassembly alert



Setting notification alerts (App)

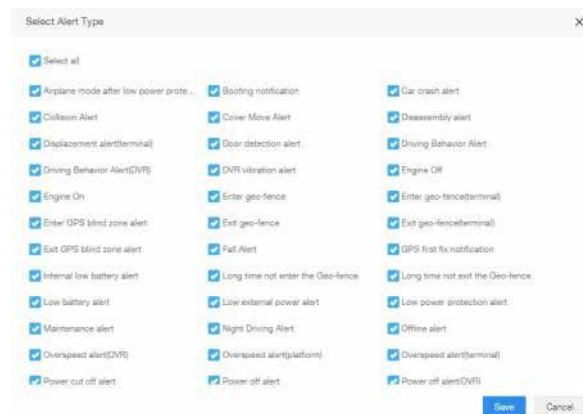

Setting notification alerts (Web)

3.9 Settings

3.9.1 Settings overview

1. Open the main menu and press **Setting**.
2. On the main settings screen, you can toggle notification events (as shown in 3.8.2 Notification Events). Further options are available from here:
 - **Command:** Remotely edit a variety of settings for the camera. More detail below.
 - **Clean Cache:** Deletes temporary data, clearing up filespace.
 - **Help:** Briefly explains various app functions and how to perform them.
 - **About:** Check for app updates and look at the Privacy Policy.

3.9.2 Settings -> Command

1. From the **Setting** screen, press **Command**.
2. From here, the following settings can be adjusted:
 - **Volume Setting:** Adjust the camera's volume settings.
 - **Sudden Acceleration Alarm, Sudden Deceleration Alarm & Sharp Turn Alarm:** Toggle on/off, set whether to upload video upon event and adjust sensitivity.
 - **Fuel/Power Remote Control:** You can cut/restore the fuel pump remotely if the fuel pump relay is wired up. Must enter correct password for this function to work.
 - **Query Status:** Query about the status of the fuel pump connection status.
"0" - Fuel pump is connected. "1" - Fuel pump is disconnected.
 - **SOS number:** Enter up to 3 mobile numbers to contact when the SOS button is pressed and held down **for at least 3 seconds**. Must enable "SOS" in Setting menu.
 - **User-defined:** Send custom commands (Under development).

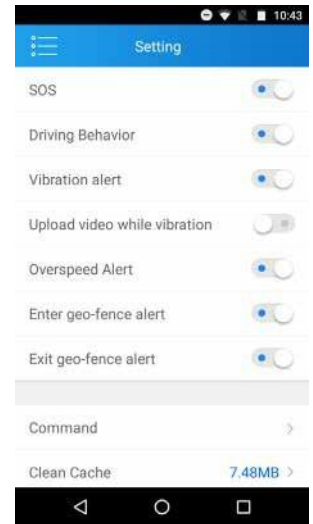

Main settings screen

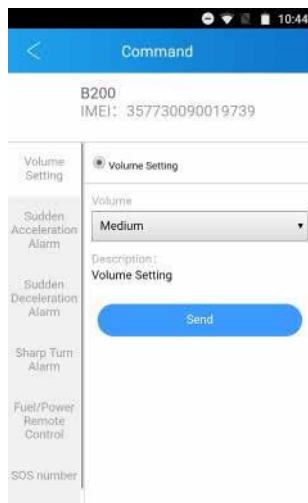

Volume Setting

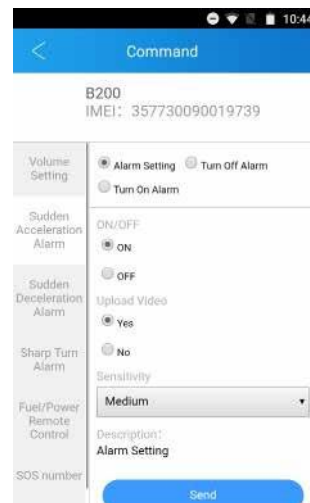

Sudden Acceleration Alarm

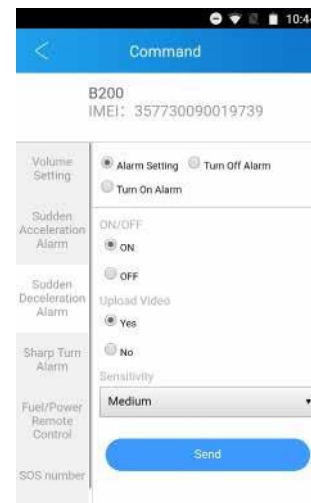

Sudden Deceleration Alarm

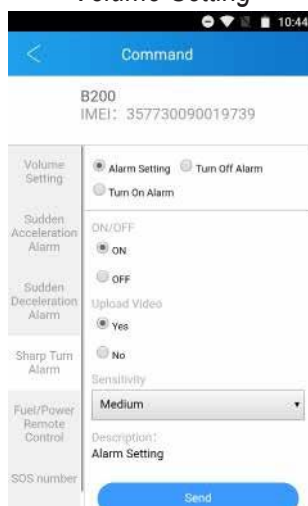

Sharp Turn Alarm

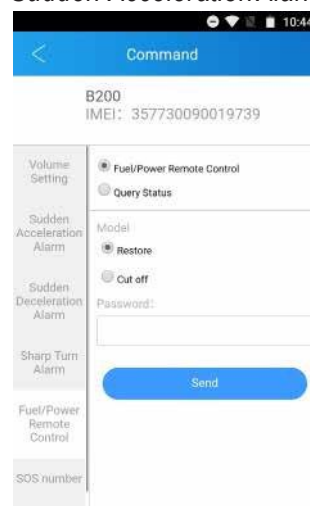

Fuel/Power Remote Control



SOS Number

SECURVIEW™

For more information, please visit:

www.securviewcctv.com



**Quick Start Guide:
MDVR-J200 (Vehicle monitoring system)**

Version: 20190418