



Wireless Door Detector

User's Manual







Foreword

General

This manual introduces the installation, functions and operations of the Wireless Door Detector (hereinafter referred to as the "door detector"). Read carefully before using the device, and keep the manual safe for future reference.

Safety Instructions

The following signal words might appear in the manual.

Signal Words	Meaning
 DANGER	Indicates a high potential hazard which, if not avoided, will result in death or serious injury.
 WARNING	Indicates a medium or low potential hazard which, if not avoided, could result in slight or moderate injury.
 CAUTION	Indicates a potential risk which, if not avoided, could result in property damage, data loss, lower performance, or unpredictable result.
 TIPS	Provides methods to help you solve a problem or save you time.
 NOTE	Provides additional information as the emphasis and supplement to the text.

Revision History

Version	Revision Content	Release Time
V1.1.1	Updated technical specifications.	March 2023
V1.1.0	<ul style="list-style-type: none"> Added technical specifications, detection performance, and battery replacing procedures. Updated descriptions of parameters. Updated images. 	January 2022
V1.0.0	First release.	January 2021

Privacy Protection Notice

As the device user or data controller, you might collect the personal data of others such as their face, fingerprints, and license plate number. You need to be in compliance with your local privacy protection laws and regulations to protect the legitimate rights and interests of other people by implementing measures which include but are not limited: Providing clear and visible identification to inform people of the existence of the surveillance area and provide required contact information.

About the Manual

- The manual is for reference only. Slight differences might be found between the manual and the product.
- We are not liable for losses incurred due to operating the product in ways that are not in

compliance with the manual.

- The manual will be updated according to the latest laws and regulations of related jurisdictions. For detailed information, see the paper user's manual, use our CD-ROM, scan the QR code or visit our official website. The manual is for reference only. Slight differences might be found between the electronic version and the paper version.
- All designs and software are subject to change without prior written notice. Product updates might result in some differences appearing between the actual product and the manual. Please contact customer service for the latest program and supplementary documentation.
- There might be errors in the print or deviations in the description of the functions, operations and technical data. If there is any doubt or dispute, we reserve the right of final explanation.
- Upgrade the reader software or try other mainstream reader software if the manual (in PDF format) cannot be opened.
- All trademarks, registered trademarks and company names in the manual are properties of their respective owners.
- Please visit our website, contact the supplier or customer service if any problems occur while using the device.
- If there is any uncertainty or controversy, we reserve the right of final explanation.

Important Safeguards and Warnings

This section introduces content covering the proper handling of the door detector, hazard prevention, and prevention of property damage. Read carefully before using the door detector, and comply with the guidelines when using it.

Operation Requirements



- Make sure that the power supply of the device works properly before use.
- Do not pull out the power cable of the device while it is powered on.
- Only use the device within the rated power range.
- Transport, use and store the device under allowed humidity and temperature conditions.
- Prevent liquids from splashing or dripping on the device. Make sure that there are no objects filled with liquid on top of the device to avoid liquids flowing into it.
- Do not disassemble the device.

Installation Requirements



- Connect the device to the adapter before power on.
- Strictly abide by local electrical safety standards, and make sure that the voltage in the area is steady and conforms to the power requirements of the device.
- Do not connect the device to more than one power supply. Otherwise, the device might become damaged.



- Observe all safety procedures and wear required protective equipment provided for your use while working at heights.
- Do not expose the device to direct sunlight or heat sources.
- Do not install the device in humid, dusty or smoky places.
- Install the device in a well-ventilated place, and do not block the ventilator of the device.
- Use the power adapter or case power supply provided by the device manufacturer.
- The power supply must conform to the requirements of ES1 in IEC 62368-1 standard and be no higher than PS2. Note that the power supply requirements are subject to the device label.
- Connect class I electrical appliances to a power socket with protective earthing.

Table of Contents

Foreword	I
Important Safeguards and Warnings	III
1 Introduction	1
1.1 Overview	1
1.2 Technical Specifications	1
1.3 Detection Performance	3
2 Checklist	4
3 Design	5
3.1 Appearance	5
3.2 Dimensions	6
4 Adding the Door Detector to the Hub	7
5 Installation	8
5.1 Replacing the Battery	8
5.2 Installing the Door Detector	8
6 Configuration	10
6.1 Viewing Status	10
6.2 Configuring the Door Detector	11
Appendix 1 Cybersecurity Recommendations	14

1 Introduction

1.1 Overview

Door detector is a wireless detector consisting of a sensor and a magnet that can send a signal to the hub and trigger an alarm when an armed door is opened. It can be set up via the DMSS app for iOS and Android phones.

1.2 Technical Specifications

This section contains technical specifications of the door detector. Please refer to the ones that correspond with your model.

Table 1-1 Technical specifications

Type	Parameter	Description
Port	Indicator Light	1 × green alarm indicator
	Button	1 × power button
Function	Tamper Alarm	Yes
	Remote Update	Cloud update
	Search	Signal strength detection
	Low Battery Alarm	Yes
Wireless Parameters	Carrier Frequency	ALM-D1-RSW1: 433.1 MHz–434.6 MHz
	Communication Distance	ALM-D1-RSW1: Up to 1,000 m (3,280.84 ft) in an open space
	Communication Mechanism	Two-way
	Encryption Mode	AES128
	Frequency Hopping	Yes
Peripheral	External Zone	1-channel external digital input  1-channel external digital input does not have any certification standards.
Temperature	Measuring Range	-15 °C to +65 °C (+5 °F to +149 °F) (Indoor)
	Measuring Precision	± 1 °C (± 1.8 °F)

Type	Parameter	Description
	Resolution	1 °C (33.8 °F)
Technical Parameter	Sensor	Reed switch
	Test Mode	Yes
	Scenario	Non-metal doors
	Movement Distance	< 40 mm (1.57")
General	Power Supply	CR123A battery
	Battery Voltage	3 VDC
	Min. Voltage	1.8 VDC
	Battery Low Threshold	2.7 VDC
	Battery Restore Threshold	2.75 VDC
	Typical Voltage	3 VDC
	Low Voltage Value	2.7 VDC
	Consumption	Quiescent current 5 uA Max current 60 mA
	PS Type	Type C
	Battery Life	5 years
	Power Consumption	ALM-D1-RSW1: Max. 70 mW
	Operating Environment	Indoor: -10 °C to +55 °C (+14 °F to +131 °F) Certified temperature: -10°C to +40°C (+14°F to 104 °F)
	Operating Humidity	10%–90% (RH)
	Product Dimensions	100.2 mm× 20.8 mm× 20.3 mm (3.94" × 0.82" × 0.80")
	Packaging Dimensions	135.0 mm× 98.5 mm× 27.8 mm (5.31" × 3.88" × 1.09")
	Installation	Bracket mount
Net Weight	70 g (0.15 lb)	
Gross Weight	115 g (0.25 lb)	
Casing	PC + ABS	

Type	Parameter	Description
Certifications	ALM-D1-RSW1: FCC CE	

1.3 Detection Performance

An alarm will be triggered when the gap between the door detector and the magnetic stick is wider than the distances shown in the table below.

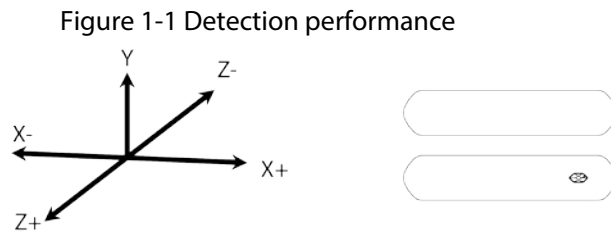

Table 1-2 Detection performance description

Axes of Operation	Event	Gap between the Door Detector and Magnetic Stick (mm)	Signal Message
Y	Far	33	I
	Close	28	S
X+	Far	20	I
	Close	18	S
X-	Far	20	I
	Close	18	S
Z+	Far	38	I
	Close	26	S
Z-	Far	28	I
	Close	26	S



- **I** here means intrusion signal; **S** here means stand by signal.
- **Far** means that the door detector is not close to the magnetic stick; **Close** means that the door detector is very close to the magnetic stick.

2 Checklist

Figure 2-1 Checklist

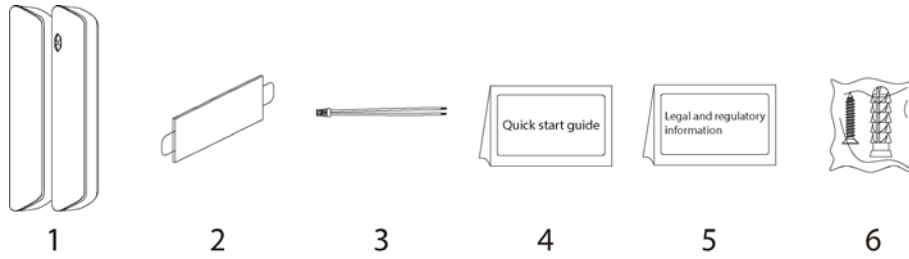

Table 2-1 Checklist

No.	Item Name	Quantity	No.	Item Name	Quantity
1	Door detector	1	4	Quick start guide	1
2	Double-sided adhesive tape	2	5	Legal and regulatory information	1
3	Cable	1	6	Screw package	2

3 Design

3.1 Appearance

Figure 3-1 Appearance

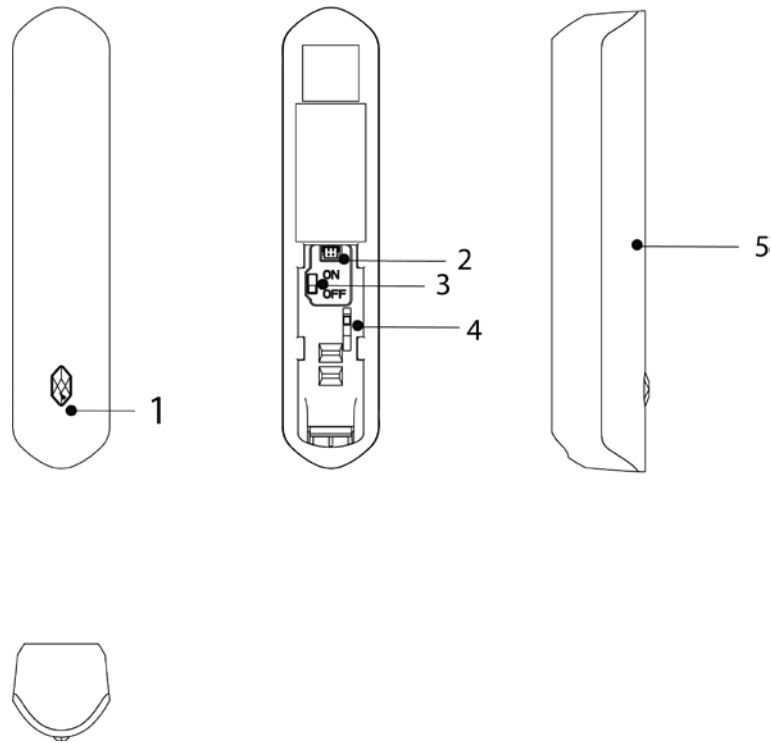
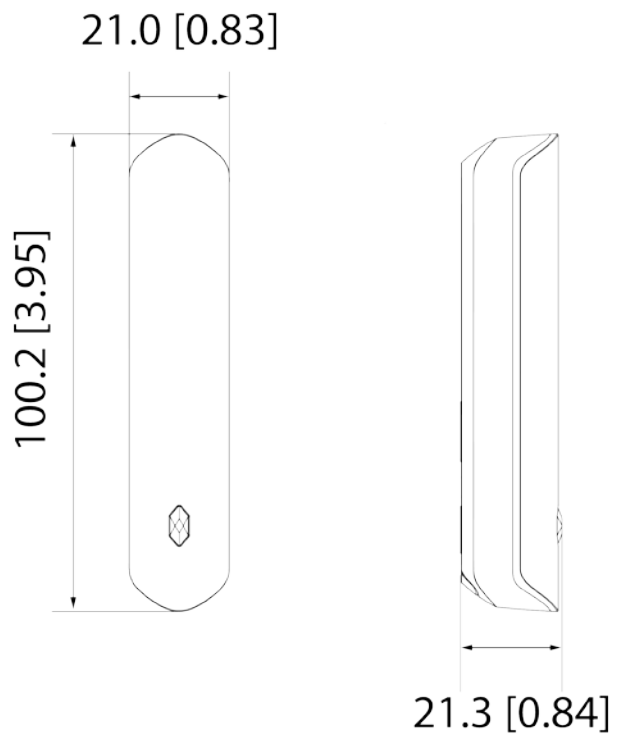

Table 3-1 Structure

No.	Name	Description
1	Indicator	<ul style="list-style-type: none"> Flashes green quickly: Pairing mode or reduced sensitivity mode. Solid green: Alarm event was triggered. Solid green for 2 seconds: Pairing successful. Slowly flashes green for 3 seconds: Pairing failed.
2	Peripheral port	Connect the peripheral with the alarm cable.
3	On/Off switch	Turn on or turn off the door detector.
4	Tamper switch	When the tamper switch is released, the tamper alarm will be triggered.
5	Back cover	If the back cover is opened, the tamper alarm will be triggered.

3.2 Dimensions

Figure 3-2 Dimensions (mm [inch])



4 Adding the Door Detector to the Hub

Before you connect door detector to the hub, install the DMSS app to your phone. This manual uses iOS as an example.



- Make sure that the version of the DMSS app is V1.001.0000000.7.R.220106 or later.
- Make sure that you have already created an account, and added the hub to DMSS.
- Make sure that the hub has a stable internet connection.
- Make sure that the hub is disarmed.

Step 1 Go to the hub screen, and then tap **Peripheral** to add the door detector.

Step 2 Tap **+** to scan the QR code at the bottom of the door detector, and then tap **Next**.

Step 3 Tap **Next** after the door detector has been found.

Step 4 Follow the on-screen instructions and switch the door detector to on, and then tap **Next**.

Step 5 Wait for the pairing.

Step 6 Customize the name of the door detector, and select the area, and then tap **Completed**.

5 Installation

5.1 Replacing the Battery

The battery has been installed when leaving the factory, and the door detector can be used directly. If the battery is dead, you need to replace the battery.

Step 1 Open the back cover of the door detector.

Figure 5-1 Open the back cover

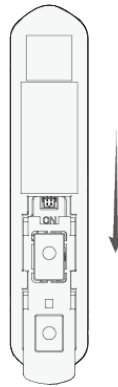

Step 2 Replace the battery.

When replacing the battery, make sure that the side marked with "+" faces the back cover of the devices.

Figure 5-2 Replace the battery



Step 3 Close the back cover of the door detector.

Figure 5-3 Close the back cover

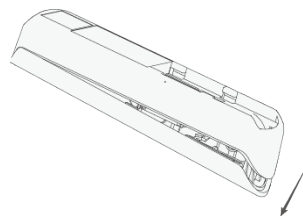

5.2 Installing the Door Detector

Before installation, add the door detector to the hub and check the signal strength of the installation location. We recommend installing the door detector in a place with a signal strength of at least 2 bars.

We recommend using expansion screws when installing the door detector.

Figure 5-4 Installation

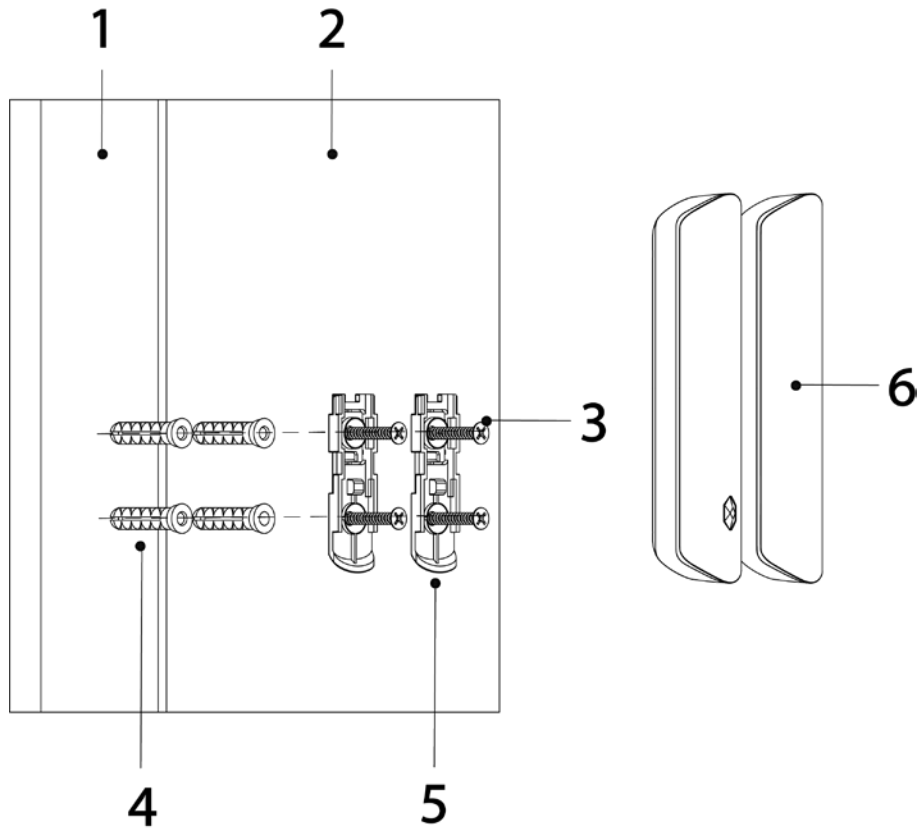

Table 5-1 Installation items

No.	Item name	No.	Item name
1	Door 1	4	Expansion bolt
2	Door 2	5	Attachment panel
3	ST3 × 18 mm self-tapping screw	6	Door detector

Step 1 Drill 4 holes in door 1 and door 2 according to the hole positions of the attachment panel.

Step 2 Put the expansion bolts into the holes.

Step 3 Align the screw holes on the plate with the expansion bolts.

Step 4 Secure the attachment panels with ST3 × 18 mm self-tapping screws.

Step 5 Put the door detector into the attachment panel.

















6 Configuration

You can view and edit general information of the door detector.

6.1 Viewing Status

On the hub screen, select a door detector from the peripheral list, and then you can view the status of the door detector.

Table 6-1 Status

Parameter	Value
Temporary Deactivate	<p>The status for whether the functions of the repeater are enabled or disabled.</p> <ul style="list-style-type: none"> ●  : Enable. ●  : Only disable tamper alarm. ●  : Disable. <p></p> <p>The function is only available when the version of the DMSS app is 1.96 or later, the hub is V1.001.0000000.6.R.211215 or later, and the door detector is V1.000.0000001.0.R.20211203 or later.</p>
Temperature	The temperature of the environment.
Signal Strength	<p>The signal strength between the hub and the door detector.</p> <ul style="list-style-type: none"> ●  : Low. ●  : Weak. ●  : Good. ●  : Excellent. ●  : No.
Battery Level	<p>The battery level of the door detector.</p> <ul style="list-style-type: none"> ●  : Fully charged. ●  : Sufficient. ●  : Moderate. ●  : Insufficient. ●  : Low.
Anti-tampering Status	The tamper status of the door detector, which reacts to the detachment of the body.
Online Status	<p>Online and offline status of the door detector.</p> <ul style="list-style-type: none"> ●  : Online. ●  : Offline.
Entrance Delay Time	Entrance and exit delay time.
Exit Delay Time	





Parameter	Value
Door Status	Open or close status of the door. <ul style="list-style-type: none"> : Open. : Closed.
24 H Protection Zone Status	Active status of the 24 h protection zone. <ul style="list-style-type: none"> : Open. : Closed.
Relay Status	The status of whether the door detector forwards accessory messages to the hub through the repeater. The function is only available when the version of the DMSS app is 1.96 or later, the hub is V1.001.0000000.6.R.211215 or later, and the door detector is V1.000.0000001.0.R.20211203 or later.
Program Version	The program version of the door detector.



6.2 Configuring the Door Detector

On the hub screen, select a door detector from the peripheral list, and then tap to configure the parameters of the door detector.

Table 6-2 Parameter description

Parameter	Description
Device Configuration	<ul style="list-style-type: none"> View door detector name, type, SN and device model. Edit door detector name, and then tap Save to save configuration.
Area	Select the area to which the door detector is assigned.
Temporary Deactivate	<ul style="list-style-type: none"> Tap Enable, and then the function of the door detector will be enabled. Enable is set by default. Tap Only Disable Tamper Alarm, and then the system will only ignore tamper alarm messages. Tap Disable, and then the function of the door detector will be disabled.

Parameter	Description
LED Indicator	<p>LED Indicator is enabled by default. For details on indicator behavior, see user's manual of the corresponding devices.</p>  <ul style="list-style-type: none"> • If LED Indicator is disabled, the LED indicator will remain off regardless of whether the door detector is functioning normally or not. • The function is only available when the version of the DMSS app is 1.96 or later, the hub is V1.001.0000000.4.R.211014 or later, and the door detector is V1.000.0000001.0.R.20210818 or later.
24 H Protection Zone	<p>Enable the 24 H Protection Zone function, and then the peripheral located in the 24 h protection zone is always active whether the security system is configured in the armed mode or not.</p>
Home Mode	<p>Enable the Home Mode, and then the selected peripherals under the hub will be armed.</p>
Delay Mode under Home Mode	<p>Enable the Delay Mode under Home Mode, the selected peripheral under the hub will be armed and the alarm will not be triggered until the end of customized delay time.</p>  <p>Only enable Home Mode first can Delay Mode under Home Mode take effect.</p>
Delay Time	<p>The system provides you with time to leave or enter the protection zone without alarm.</p> <ul style="list-style-type: none"> • Delay Time for Entering Arming Mode: When you enter the zone, if you do not disarm the system before the delay ends, an alarm will be triggered.  <p>Make sure that the delay time for entering arming mode is no longer than 45 seconds in order to comply with EN50131-1.</p> <ul style="list-style-type: none"> • Delay Time for Exiting Arming Mode: When you are in the zone and arm the system, if you do not leave the zone before the delay ends, an alarm will be triggered. You can select from 0 s to 120 s.  <p>The arming mode will be effective after the delay time.</p>
External Detector Access	<p>Connect the wired peripheral with the cable.</p>
Siren Linkage	<p>When an alarm is triggered, the peripherals will report the alarm events to the hub and alert with siren.</p>
Alarm-video Linkage	<p>When an alarm is triggered, the peripherals will report the alarm events to the hub and then will link events.</p>
Video Channel	<p>Select the video channel as needed.</p>

Parameter	Description
Signal Strength Detection	Test the current signal strength.
Detector Test	Detect whether the peripheral works.
Transmit Power	<ul style="list-style-type: none"> • Select from high, low, and automatic. • The higher the transmission power, the farther the signal can travel, but the greater the power consumption.  <ul style="list-style-type: none"> • If you select Low, and then the door detector will enter reduced sensitivity mode until you select another option. • The reduced sensitivity mode is only available when the version of the DMSS app is 1.97 or later, the hub is V1.001.0000000.6.R.211228 or later, and the door detector is V1.000.0000001.0.R.20211203 or later.
Cloud Update	Update online.
Delete	Delete the door detector.  Go to the hub screen, select the peripheral from the list, and then swipe left to delete it.

Appendix 1 Cybersecurity Recommendations

Cybersecurity is more than just a buzzword: it's something that pertains to every device that is connected to the internet. IP video surveillance is not immune to cyber risks, but taking basic steps toward protecting and strengthening networks and networked appliances will make them less susceptible to attacks. Below are some tips and recommendations from Watchguard on how to create a more secured security system.

Mandatory actions to be taken for basic device network security:

1. Use Strong Passwords

Please refer to the following suggestions to set passwords:

- The length should not be less than 8 characters.
- Include at least two types of characters; character types include upper and lower case letters, numbers and symbols.
- Do not contain the account name or the account name in reverse order.
- Do not use continuous characters, such as 123, abc, etc.
- Do not use overlapped characters, such as 111, aaa, etc.

2. Update Firmware and Client Software in Time

- According to the standard procedure in Tech-industry, we recommend to keep your device (such as NVR, DVR, IP camera, etc.) firmware up-to-date to ensure the system is equipped with the latest security patches and fixes. When the device is connected to the public network, it is recommended to enable the "auto-check for updates" function to obtain timely information of firmware updates released by the manufacturer.
- We suggest that you download and use the latest version of client software.

"Nice to have" recommendations to improve your device network security:

1. Physical Protection

We suggest that you perform physical protection to device, especially storage devices. For example, place the device in a special computer room and cabinet, and implement well-done access control permission and key management to prevent unauthorized personnel from carrying out physical contacts such as damaging hardware, unauthorized connection of removable device (such as USB flash disk, serial port), etc.

2. Change Passwords Regularly

We suggest that you change passwords regularly to reduce the risk of being guessed or cracked.

3. Set and Update Passwords Reset Information Timely

The device supports password reset function. Please set up related information for password reset in time, including the end user's mailbox and password protection questions. If the information changes, please modify it in time. When setting password protection questions, it is suggested not to use those that can be easily guessed.

4. Enable Account Lock

The account lock feature is enabled by default, and we recommend you to keep it on to guarantee the account security. If an attacker attempts to log in with the wrong password several times, the corresponding account and the source IP address will be locked.

5. Change Default HTTP and Other Service Ports

We suggest you to change default HTTP and other service ports into any set of numbers between

1024–65535, reducing the risk of outsiders being able to guess which ports you are using.

6. **Enable HTTPS**

We suggest you to enable HTTPS, so that you visit Web service through a secure communication channel.

7. **MAC Address Binding**

We recommend you to bind the IP and MAC address of the gateway to the device, thus reducing the risk of ARP spoofing.

8. **Assign Accounts and Privileges Reasonably**

According to business and management requirements, reasonably add users and assign a minimum set of permissions to them.

9. **Disable Unnecessary Services and Choose Secure Modes**

If not needed, it is recommended to turn off some services such as SNMP, SMTP, UPnP, etc., to reduce risks.

If necessary, it is highly recommended that you use safe modes, including but not limited to the following services:

- SNMP: Choose SNMP v3, and set up strong encryption passwords and authentication passwords.
- SMTP: Choose TLS to access mailbox server.
- FTP: Choose SFTP, and set up strong passwords.
- AP hotspot: Choose WPA2-PSK encryption mode, and set up strong passwords.

10. **Audio and Video Encrypted Transmission**

If your audio and video data contents are very important or sensitive, we recommend that you use encrypted transmission function, to reduce the risk of audio and video data being stolen during transmission.

Reminder: encrypted transmission will cause some loss in transmission efficiency.

11. **Secure Auditing**

- Check online users: we suggest that you check online users regularly to see if the device is logged in without authorization.
- Check device log: By viewing the logs, you can know the IP addresses that were used to log in to your devices and their key operations.

12. **Network Log**

Due to the limited storage capacity of the device, the stored log is limited. If you need to save the log for a long time, it is recommended that you enable the network log function to ensure that the critical logs are synchronized to the network log server for tracing.

13. **Construct a Safe Network Environment**

In order to better ensure the safety of device and reduce potential cyber risks, we recommend:

- Disable the port mapping function of the router to avoid direct access to the intranet devices from external network.
- The network should be partitioned and isolated according to the actual network needs. If there are no communication requirements between two sub networks, it is suggested to use VLAN, network GAP and other technologies to partition the network, so as to achieve the network isolation effect.
- Establish the 802.1x access authentication system to reduce the risk of unauthorized access to private networks.
- Enable IP/MAC address filtering function to limit the range of hosts allowed to access the

device.

More information

Please visit Watchguard's official website (www.watchguardsystems.com.au) for security announcements and the latest security recommendations.

You deserve to feel safe, secure & protected