

G5W Alarm System

User Manual

Congratulations on buying this Chuango G5W alarm system. Installing the Chuango G5W alarm system is easy and quick. Before using the product we recommend you read the manual first. There are some parts of the installation which have to be done in the right order to complete the installation successfully.

Contents

Overview of the Chuango G5W alarm system	1~4
In the box	1~2
Included accessories	3
Operating principle of the alarm system	4
Sensors	5~7
Sensor placement	5
Grouping sensors	6
Renaming sensors	7
Test mode alarm system	7
Record alarm message	7
Getting started	8~10
Inserting SIM card	8
Turning on the control panel	9
Network connection (indicator)	9
Settings inquiry by SMS	9~10
Control Panel Operation	11~15
Arming the system	11
Partially arming the system	11
Disarming the system with the control panel	11
Arming/Disarming the system by RFID tag	11
Record and play back voice message	12
Naming RFID tags	12
Speed dial	12
Phone dial	13
Changing the language	13
Disarming the alarm system by SMS	14
Arming the system by SMS	14
Partially arming (home mode) the system by SMS	14
Two-way talk	15
Leaving a message by phone call	15
Phone operation when receiving emergency call	15

Apple and Android App	16~17
Adding an account	16
G5W alarm App overview	17
Setting up the alarm system with the App	18~31
Request alarm system status by SMS	18
Store emergency telephone numbers	19
Store emergency SMS numbers	20
Store SMS number for RFID tags arm/disarm notification	21
Store speed dial number	22
Change RFID tags name	23
Change sensors name	24
Change system arm delay time (exit delay time)	25
Internal siren setting	26
Change disarm password	27
Setting single zone alarm delay time	28
Store SMS numbers for status alerts	29
Wireless siren arm/disarm tone	29
Delete accessories	30
Restore system to default setting	30
Signal checking by SMS	30
SMS notification of tampering sensors	30
Arm & Disarm by free phone call	30
Connect (new) wireless accessories & RFID tags	31
Connect new wireless sensors	
Connect new RFID tags	
Connect and delete wireless sirens	31
Remote control	32~33
Remote control overview	32
Arm	32
Disarm	32
Home mode	33
Mute mode	33
Emergency call	33
Connect a new remote control	33

Pet-Immune PIR motion detector	34~38
PIR motion detector overview	34
LED indicator	34
Inside PIR motion detector	35
Infrared sensors	
Tamper switch	
LED On/Off	
Rearside PIR motion detector	36
Test mode	
Power saving mode	
Connecting wireless PIR motion detector	
Installing PIR motion detector	37
Test mode PIR motion detector	38
Wireless door/window contact	38~40
Front view door/window contact	38
LED indicator	39
Inside the door/window contact	39
Tamper switch	
Installation tips	39~40
Connecting door/window contact	40
Electric Lock Output	40
Installing control panel	41
Wall mount	
Desk stand	
Technical specifications	42~45
Control panel	42
PIR-910 Wireless PIR Motion Detector	43
DWC-102 Wireless Door/Window Contact	44
RC-80 Wireless Remote Control	45
TAG-26 (RFID tag)	45
Troubleshooting	46~48

Overview of the Chuango G5W alarm system

In the box

Front View

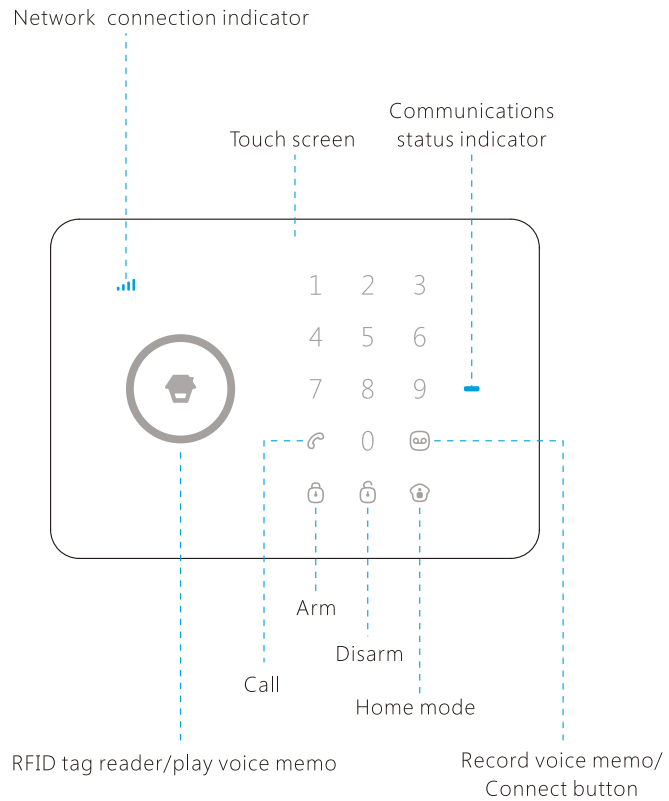

Rear Side

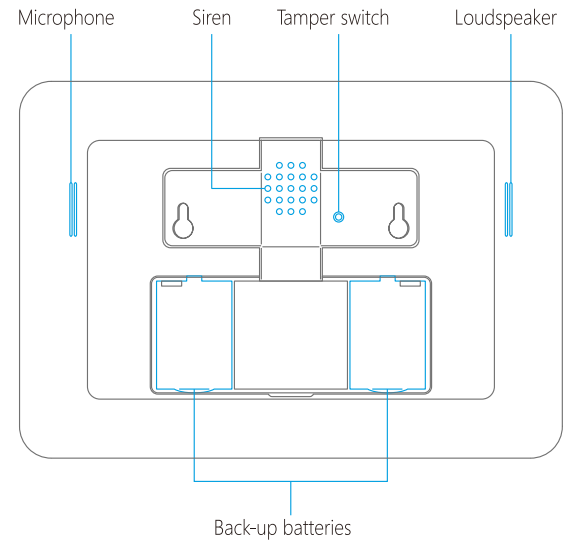

Included accessories

The Chuango G5W Alarm System has the following accessories included in the box:

- English user manual
- English quick guide

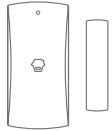

1 x Wireless door/window contact DWC-102

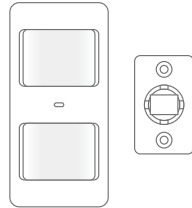

1 x Pet-Immune PIR motion detector PIR-910



2 x RFID tags TAG-26



2 x Multifunctional remote control RC-80

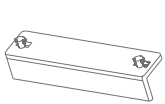

1 x Desk stand

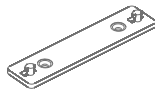

1 x Wall mount

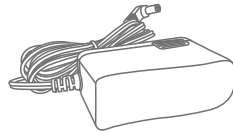

1 x Adapter

Operating principle of the G5W alarm system

The alarm system will receive a signal when a sensor has been triggered. The G5W control panel will sound the internal siren and send an SMS to all stored phone numbers. When texting is completed it will then call all stored phone numbers. If a strobe siren has been added to the system it will also sound and flash for the duration of the pre-programmed ringing time limit. Once the time limit is reached the G5W will reset the timer and the system will remain armed in case there is a further alarm activation.

Note: If the G5W is disarmed before it completes texting and/or calling stored numbers, this function will stop because the alarm has been disarmed by an authorised user.

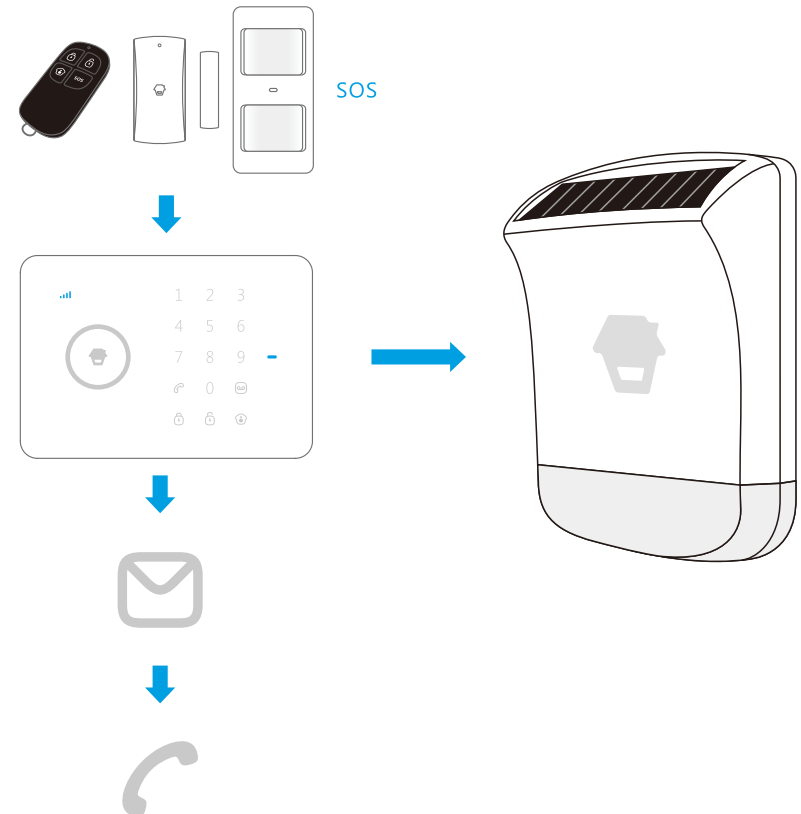

Sensors

Sensor placement

The alarm system is more effective with well-placed and set sensors. Determine which areas you want to monitor and with which sensor. In the picture below are potential places shown for different types of sensors from which you can determine what the best placing is for your space.

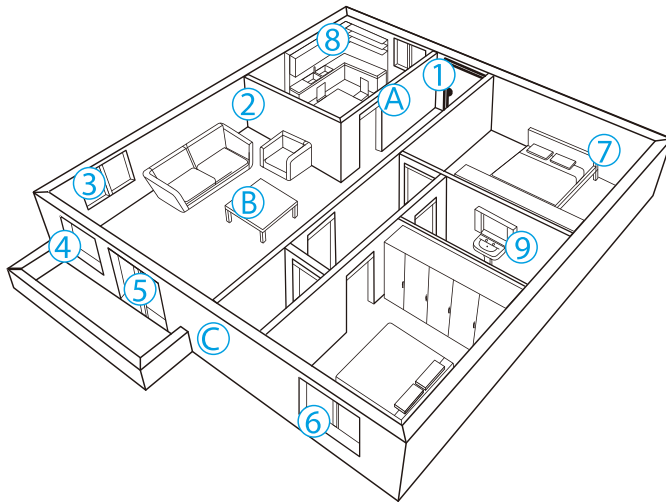

A. Alarm panel

B. Remote control

C. Siren

- | | |
|------------------------|------------------------|
| 1. Front door | : Door/window contact |
| 2. Living area | : PIR motion detector |
| 3. Window: living area | : Door/window contact |
| 4. Window: living area | : Door/window contact |
| 5. Terrace door | : Door/window contact |
| 6. Window | : Door/window contact |
| 7. Bedroom | : PIR motion detector |
| 8. Kitchen | : Gas detector |
| 9. Wash room | : Water flood detector |

Grouping sensors

Each sensor can be placed in a group. Four different groups can be selected. The home group, normal group, 24-hour group or a single zone group.

IMPORTANT: Determine before installing the alarm system which group a sensor should be set to.

IMPORTANT: If sensor group has to be changed, the sensor must reconnect to the control panel.

The figure below shows the four different group settings as can be found inside the sensors. Move the bridges in the desired configuration to set up the group in each sensor.

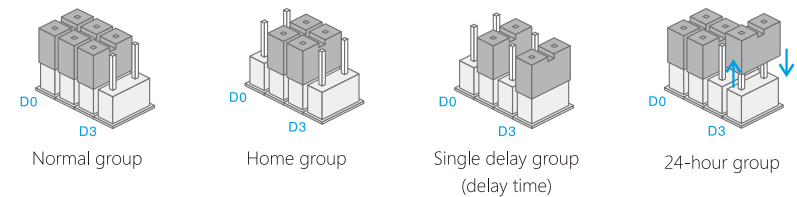

Normal group: The supplied door/window contact(s) by default are set on the normal group with bridges set on 'D0'D1'and 'D2'. When the G5W is in Arm or Home mode, all the sensors in the normal group will be monitored.

Home group: The supplied PIR motion detector(s) by default are set to the home group with jumpers set on 'D1' and 'D2'. When the G5W is set to Home mode , all sensors in the home group will be ignored by the system. Using the home mode means that it is possible to partially arm the house with the advantage of being able to freely move about without triggering the alarm. When the G5W is set to Arm mode, all sensors in home group will be monitored as well as the other sensors.

Single delay group: One or more sensors can be set to the entry delay group which means there will be a delay before the G5W will be triggered. The entry delay group is used for the likes of an entry door and/or motion sensors that will be triggered on the entry path to gain access to the home. The default delay setting is 30 seconds but this can be changed to between 0 - 300 seconds. Refer to page 28. When the G5W is set to either 'Arm or Home' mode, all sensors in the entry delay group will be monitored. The Single delay group also has a door chime feature that can be turned on or off by texting '46701' = On or '46700' = Off. The default is set to off.



24-hour group: The 24-hour group ('D0, D1 and D3') is recommended as default setting for sensors which can detect smoke or gas for instance. When set to this group the sensor is always active and will always send a signal to the control panel when triggered, regardless whether the system is armed or disarmed without delay.

Renaming sensors



The supplied motion detector and door/window contact are by default paired with the alarm system. Every sensor is called a zone and every sensor will get it's own zone number assigned. Their sequence in naming follows pairing order, for example, the first sensor is by default assigned to zone 1 and so on. You can rename the first 30 zone names ie. Front Door, Hallway PIR, Master Bedroom etc.

Test mode alarm system

The alarm system can be put in a test mode. This will cause the alarm to beep three times when it receives a signal from a sensor which is triggered, instead of ringing the siren.

Disarm (default code: 1234) the system, and then press the  button three times in a row on the panel until the system beeps once. After 10 minutes the system will automatically exit the test mode. It is also possible to exit the test mode by pressing the  button.

Record alarm message

When the alarm is activated the control panel will call the set emergency numbers and play a message. This message can be changed by pressing the  button, then type the disarm code (default 1234), press again the  button and finally press the  button. From that point you have 10 seconds to leave a message.

Getting Started

Inserting SIM card

Before inserting the SIM card, please perform the following steps:

1. Make sure the alarm system is power off.
2. IMPORTANT: Remove the (default) code permanently from the SIM card.
3. Turn off the voice mail function if it is enabled.
4. Insert the SIM card into the SIM card holder from the alarm system as shown in the illustration below. Slide the SIM card holder open before putting the SIM card in.

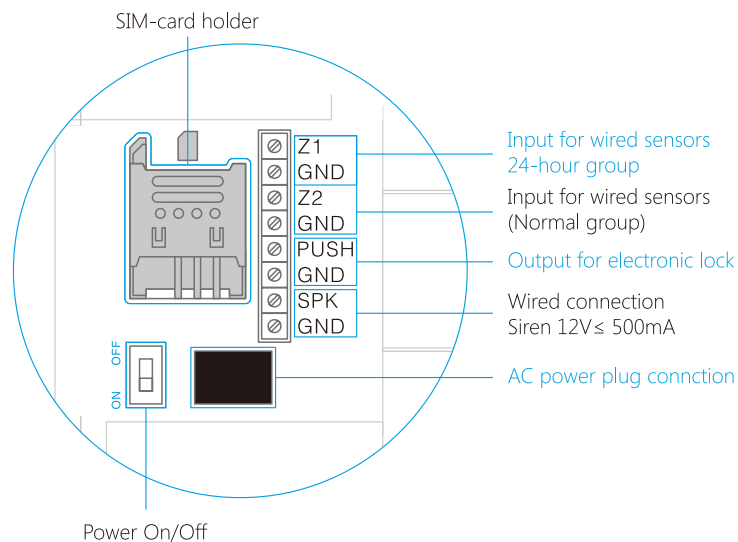

IMPORTANT: In order to use and set up the alarm system, SMS texting will be used. The use of SMS texting costs money. Consult your carrier for the costs.

IMPORTANT: The Android and/or Apple App both make use of SMS.

Turning on the control panel

Connect the power adapter to the connector in the back of the system. Then slide the power switch to 'On'.

Network connection (indicator)

After switching on the system, the network indicator is steady on. This indicates that the control panel is searching for a network. When connected to a network the LED indicator will flash once every second.

Note: If the G5W control panel sounds a long beep once per 15 seconds, it means that it has disconnected from the network and your attention is required. You can stop this alert by entering the disarm password (default 1234) followed by the unlock button. Otherwise the G5W will stop beeping once the connection to the network has been restored. Make sure the security code of the SIM card is permanently deactivated.

Settings inquiry by SMS

The settings of the alarm system can be changed by simply sending an SMS with a mobile phone. You can request an entire menu for information on possible SMS commands. The complete menu consists of three parts which can be requested by sending one, two or three question marks as can be seen in the pictures below.



'0' Disarm
'1' Arm
'2' Home mode
'3' Two-way talk
'4' Call-back voice memo
'00' Settings inquiry
'??' Store phone and SMS No.



'5' Store alarm phone No.
'6' Store alarm SMS No.
'7' Store SMS No. for RFID tags
'8' Store speed dial phone No.
'801-830' RFID tags SMS notice
'???' System setups



'901-930' Zone name
'11' System arm delay time
'12' Siren volume and ringing time
'13' Disarm password
'14' Single zone alarm delay time
'16' SMS Number for Status Alerts

Note: Two test messages will be received.

Note: If you can not receive the reply message from the control panel, please send 'CSQ' in a message to the SIM card in the control panel. It will reply an SMS and shows the signal strength, the number value is between 1 - 31. The higher the number value is means a stronger signal in that location. Find a location with good signal to place the control panel.

Control Panel Operation

Arming the system ('All groups')

Press . All the sensors will be activated.

Partially arming the system ('Home group')

Press . Sensors which are set to the home group will not be active when home mode of the panel is activated. All other sensors in other groups will remain active.

Disarming the system with the control panel

Disarming the system with the control panel can be done by entering the 4-digit password (default 1234) and press the button. You will hear one beep and the system will be disarmed. If you hear three beeps the password is entered incorrectly.

Arming/Disarming the system by RFID tag

Hold the RFID tag close to the RFID reader (blue circle on the left of the control panel). The system will beep as a confirmation it is disarmed. Swiping the RFID tag twice in 3 seconds will arm the system.

IMPORTANT: The control panel must be connected to AC to use a RFID tag to arm or disarm the system.

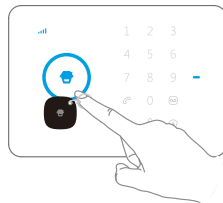

Record and play back voice message

Press the button for 3 seconds to record a personal message up to 10 seconds. If your message is shorter than 10 seconds, press the button to stop recording. The voice message can be played back by pressing the blue circle.

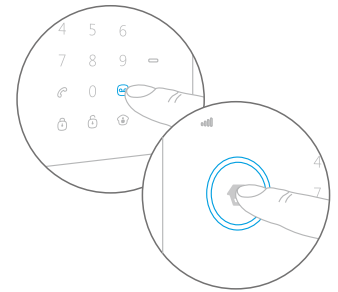

Naming RFID tags

RFID tags can be given a name. If someone arms or disarms the alarm system an SMS message with the name will be sent to the pre-stored RFID text number.

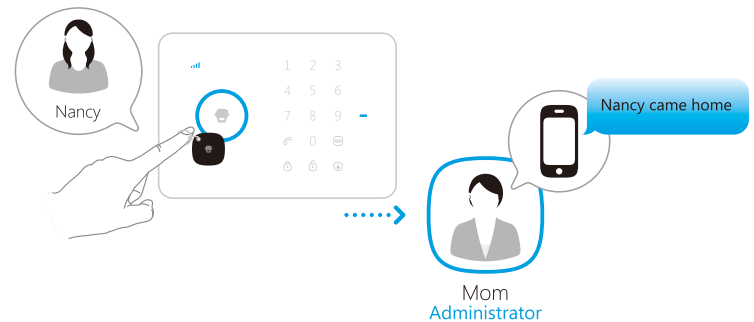



IMPORTANT: The administrator can only receive a notification if the RFID tag has been assigned and an SMS number for RFID tags is stored. (Settings can be found on page 21 and 23.)

Speed dial

When you press , the system will dial the preset emergency number immediately. The call ends when you press again. How to set the speed dial number can be found on page 22.

Phone dial

You can directly enter a phone number and press the  button. The system dials out and you can make the call via the built-in microphone and speaker of the alarm system. When you press  again the call is ended.

Changing the language

Please change the system language before setting.

English

Send an SMS message with '0001' to the telephone number of the SIM card in the control panel. The language of the alarm system will be changed into English. The control panel will send an SMS message to confirm the language is set successfully.



Dutch

Send a SMS message with '0031' to the telephone number of the SIM card in the control panel. The language of the alarm system will be changed into Dutch. The control panel will send an SMS message to confirm the language is set successfully.



Note: The language can also be set in the G5W Alarm App.

Disarming the alarm system by SMS

The main menu, which you receive after texting '?', will display the command for disarming the system ('0'). If you want to disarm the system you only have to send a '0' to the number of the SIM card in the control panel. You will receive a confirmation if it succeeded as shown in the picture below.

Disarming



System disarmed.

Arming the system by SMS

If you want to arm the system you only have to send a '1' to the number of the SIM card in the control panel.

Arming



System armed.

Partially arming (home mode) the system by SMS

If you want to partially arm the system you only have to send a '2' to the number of the SIM card in the control panel.

Home Mode (Stay)



System in home mode.

Two-way talk

Send a text message with number '3' to the telephone number of the SIM card in the control panel. You will be called back by the system and will be able to listen and/or speak.

3

Leaving a message by phone call

Send a text message with number '4' to the telephone number of the SIM card in the control panel. You will be called by your system. Pick up the phone, and leave a 10 second message. The message can be played back by pressing the blue circle.

4

Phone operation when receiving emergency call

When the alarm system is triggered the control panel will call the set emergency numbers. The following commands can be used to command the alarm system:

SMS command	Input
Disarm	0
Arm	1
Turn off siren	6
Turn on siren	9
Two-way talk	*
Replay alarm voice message	#

Apple and Android App

The Chuango G5W alarm system can also be operated with an App. You can download it by searching the keywords 'G5W Alarm' in the App Store or Google Play. Download and install the App on your smartphone.



IMPORTANT: The Android and/or Apple App both make use of SMS texting.

Adding an account

The alarm system can be operated with the G5W Alarm App. When using the Apple App there will be set up a SMS text message automatically for every function. Press the 'send' button to send the text message and set the function you have chosen. When using an Android smartphone the App will send a text message in the background without needing to confirm sending the message.

Launch the App on your phone and select 'Add account'.

Enter a name for the G5W alarm (eg. Alarm home) and enter the mobile number of the SIM card installed in the alarm system.

Once the account is added it will appear on the home screen of the app.



IMPORTANT: Always start the SIM card telephone number with the area code of your country (eg. 0031 for the Netherlands). This will allow you to operate the alarm system abroad.

G5W alarm App overview

The illustration below shows the functions of the home screen of the App. Other tabs will be explained in the following pages.

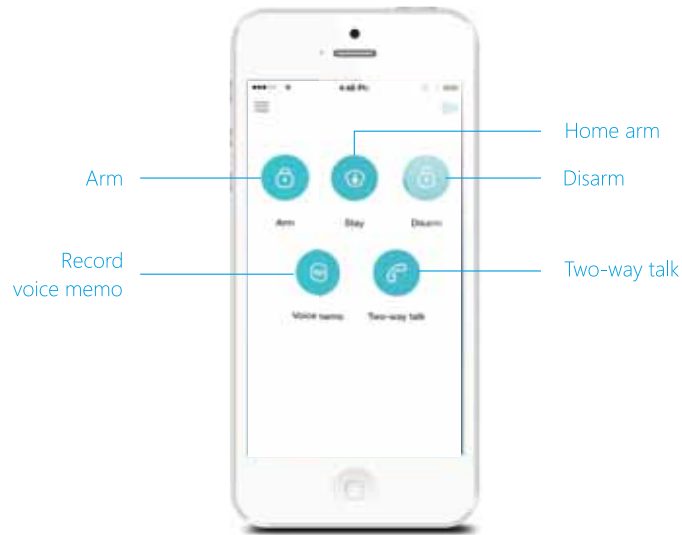

Setting up the Alarm System with the App

Setting the alarm system can be done by sending text messages but also by using the App. This chapter will show how this can be done for all the functions.

Request alarm system status by SMS

Send a text message with '00' to the SIM card telephone number in the control panel.

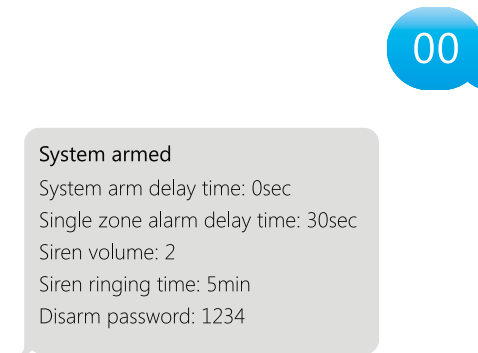

In the G5W Alarm App press the following button:



Store emergency telephone numbers

Emergency numbers are the telephone numbers which have to be called when the alarm goes off. To get a list of the current settings, send '5' to the control panel.

5

TEL:

- 1.
- 2.
- 3.
- 4.
- 5.

Copy the received SMS message entirely and paste it into a new text message. Here you can fill in all the numbers you would like. It's recommended to start with your area code of your country. You can specify multiple phone numbers in the same text message. When you have finished the entry the message can be sent.

Right is an example of a list of numbers filled in the text message.

TEL:

1. 00316123654789
2. 00316123654788
3. 00316123654787
4. 00316123654786
5. 00316123654785

Store alarm phone No. successfully.

After sending the message it will send back a message from the control panel to confirm the new settings.

With the G5W Alarm App this setting can be done as follows:

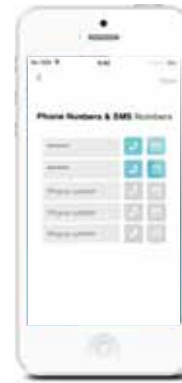

IMPORTANT: Only phone numbers stored in the alarm system can make changes and modify the system.

Store emergency SMS numbers

Emergency SMS numbers are the numbers that should be texted to when the alarm goes off. When sending a '6' you will receive the current settings. Copy and edit the text message and send it back. After sending the message it will send back a message from the control panel to confirm the new settings.

6

SMS 1:

1. 00316123654789
2. 00316123654788
3. 00316123654787
4. 00316123654786
5. 00316123654785

Store SMS number for RFID tags

The SMS number for RFID tag is the number which will be used to send a text message to when a RFID tag is used to arm or disarm the system.

7

SMS No. for RFID tags
(0-20 digits):
1.

Copy and edit the received text message and send it back with the new telephone number. After sending the message it will send back a message from the control panel to confirm the new settings.

In the App:



Store speed dial number

In this menu you can assign a phone number that will be stored as speed dial number. You can speed dial by pressing the  button.

8

Speed dial phone number
(0-20 digits):
1.

Copy and edit the received text message and send it back with the new telephone number. After sending the message there will be send back a message from the control panel to confirm the new settings. It is highly recommended to start with your area code or land code.

In the App:

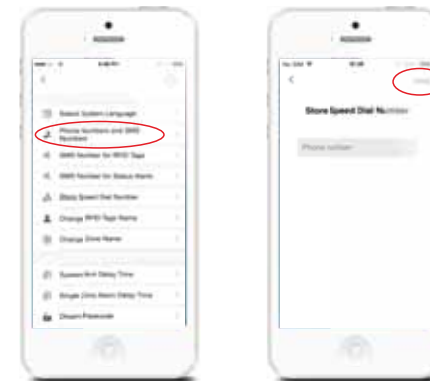

Change RFID tags name

The first 30 RFID tags can be renamed. Sending a text message with "801", "802", "803" to "830", you can edit the names linked to each tag.

801

Change RFID tags SMS notice:
1.

Left is the response message of the alarm system shown when texting '801' to the control panel. Copy the message and adjust the names behind the numbers as shown below.

Change RFID tags SMS notice:
1. Tom

Change RFID tags SMS notice successfully.

In the App:

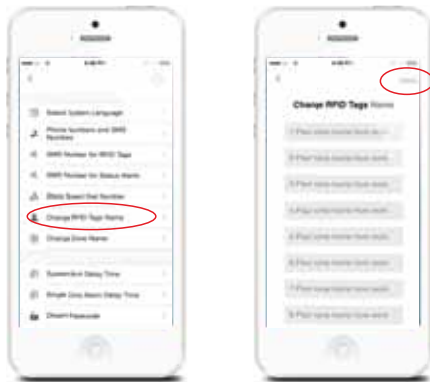

Change sensor name

Each sensor is referred to as a zone. The first 30 sensors (1-30) can be changed according to personal reference. Each sensor (zone) has 30 free characters to fill in a new name. The name of the sensors from zone 31 and higher can't be adjusted. When sending a text message with '901', '902', '903' to '930' you will receive a message back with the zone number and name.

901

Zone 1 name: Zone 1 alarm

To change the name of the zone you can copy the received text message and replace 'Zone 1 alarm' for a name of your choice.

Zone 1 name: Entrance door sensor

After sending this message you will receive a confirmation of the new settings being adjusted successfully.

In the App:

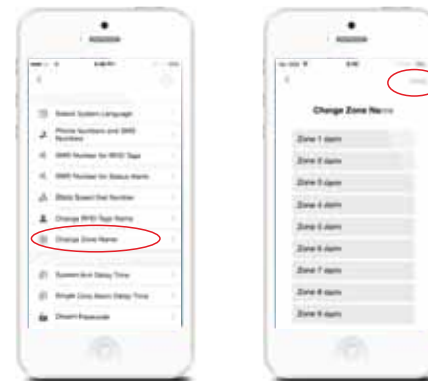

Change system arm delay time (exit delay time)

The system can be armed with a time delay. When a delay time is set you will hear a beep every second as a warning of this delay. The beep will go faster in the last 15 seconds.

11

System arm delay time
(0-300 sec):
0

Left is the response message of the alarm system shown when texting '11' to the control panel. Copy the message and adjust the time as shown below.

System arm delay time
(0-300 sec.):
30

Set delay time successfully.

In the App:

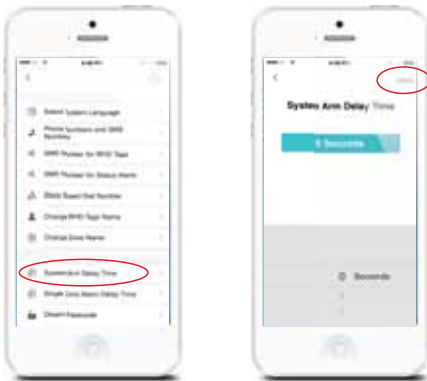

Internal siren setting

Arm/disarm tone, alarm volume and duration of the internal siren can be adjusted in this menu.

Arm/Disarm tone: The default setting is ON, it can be turned off by texting '24700' to the control panel or turned on by texting '24701'.

Alarm volume and duration:

12

Siren volume(0 Mute,
1 Low, 2 High):
2
Siren ringing time(1-9min):
5

Left is the response message of the alarm system shown when texting '12' to the control panel. Copy the message and adjust the volume ('0, 1 or 2') of the siren and the duration of the siren as shown below.

Siren volume (0 Mute, 1 Low, 2 High):
0
Siren ringing time (1-9 min):
3

Set siren volume and ringing time successfully.

In the App:

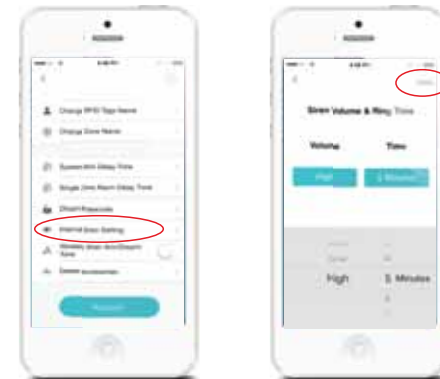

Change disarm password

13

Disarm password (4-6 Digits):
1234

Left is the response message of the alarm system shown when texting '13' to the control panel. Copy the message and adjust the battery as shown below.

Disarm password(4-6 Digits):
8888

Set disarm password successfully.

In the App:

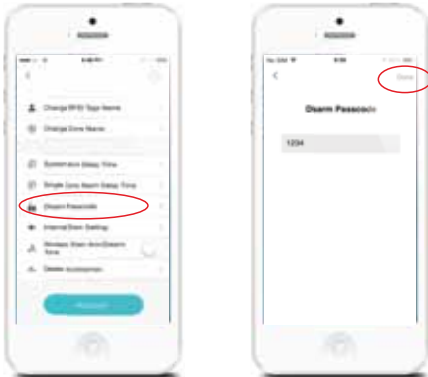

Setting single zone alarm delay time

After setting single zone alarm delay time, when the single zone sensor is triggered, the control panel will beep once per second instead of alarming immediately. This allows the user time to disarm the system from the control panel. If the system is not disarmed within the delay time then the alarm will be triggered.

14

Below is the response message of the alarm system shown when texting '14' to the control panel. Copy the message and adjust the delay time for the single zone sensor as shown below.

Single zone alarm delay time (0-300 sec.):
30

Single zone alarm delay time (0-300 sec.):
15

Set single zone delay time successfully.

In the App:

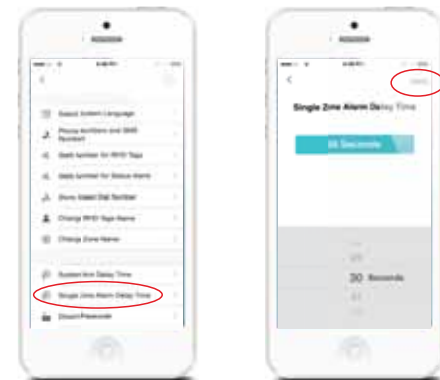

Store SMS numbers for status alerts

The stored number can receive SMS in case of low battery, power failure or recovery. You can store the numbers by texting '16' to the control panel or by App.



Wireless siren arm/disarm tone

If you have a wireless siren with your system you can turn on or off the arm/disarm tone by texting '63701' = On or '63700' = Off.

Note: The default setting is off.

Delete accessories

Option 1: SMS

You can delete the wireless sensors (door/window contacts, PIR detectors) by texting "21" to the SIM card number in the control panel.

You can delete the RFID tags by texting "22" to the SIM card number in the control panel.

You can delete the remote controls by texting "23" to the SIM card number in the control panel.

Option 2: App

You can delete the wireless sensors/ RFID tags/ remote controls from App.

Option 3: Control Panel

You can delete the sensors one by one from control panel. For example, if you want to delete zone 1 sensor:

1. Enter '1234' (or new disarm password);
2. Press [☎];
3. Enter '01';
4. Press [🔒].

Restore system to default setting

Also called a 'hard reset'. This should also be performed when changing the SIM card.



Long pressing tamper switch for 4 seconds and then quick pressing it 5 times in 3 seconds can also restore the control panel to default setting, and the control panel will beep twice.

Signal checking by SMS

To check the 3G signal strength send 'CSQ' in a text message to the SIM card mobile number in the control panel. The signal strength number value is between 1 - 31. The higher the number value is means a stronger 3G signal in that location.

CSQ

SMS notification of tampering sensors

The stored numbers on page 19 will receive an SMS message when a tamper alarm condition occurs. The zone name will appear in the SMS along with the words 'tamper alarm'. This feature only applies to sensors with a built-in tamper switch.

Arm & Disarm by free phone call



Arming the alarm system can be done by calling the SIM card telephone number in the control panel. When you hear the dialling tone, hang up. You will be called back by the same number. Do not answer but decline the call. The alarm will be armed.

Disarming the alarm system can be done by calling the SIM card telephone number. Hold on until the system disconnects by itself. The alarm system will not call you back and the alarm system will be disarmed.

IMPORTANT: To arm or disarm the alarm system, make sure voicemail is disabled on the SIM card of the alarm system.

Connect (new) wireless accessories & RFID tags

Connect new wireless sensors

The included sensors are paired with the control panel by default. If you want to pair new sensors, follow these instructions: Enter the password and press the  button on the control panel. The  button lights up. Now you can pair a sensor by triggering it. When you hear a beep from the control panel the sensor is paired successfully. If you hear the control panel beep twice the sensor has already been paired before.

Connect new RFID tags

Enter the password and press the  button on the control panel. The button lights up. Now you can hold a RFID tag in front of the blue circle on the control panel. When you hear a beep from the control panel the RFID tag is paired successfully. If you hear the control panel beep twice the RFID tag has already been paired before.

IMPORTANT: The RFID tag does only function when the control panel is connected to AC.

Connect and delete wireless sirens

This siren is an extra accessory. Press the connect button on the siren for 0.5 seconds. Siren beeps once and its LED starts to flash. Now press the arm  button on the control panel. You will hear a single beep when paired successfully. Hold the connect button on the wireless siren, a beep is heard means the connection between wireless siren and control panel is deleted.

Remote control

Remote control overview

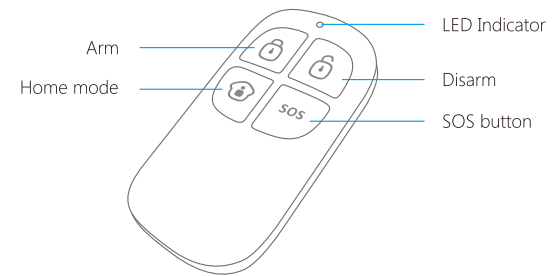

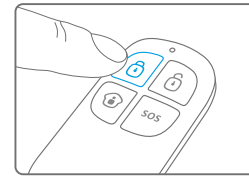

Arm

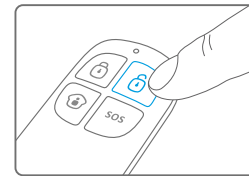

Press  to arm the alarm system. The LED indicator will light up and the siren will beep once to confirm the alarm system is armed.

Disarm



Press  to disarm the alarm system. The LED indicator will light up and the siren will beep twice to confirm the alarm system is disarmed.

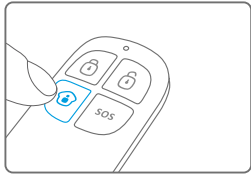

Home mode

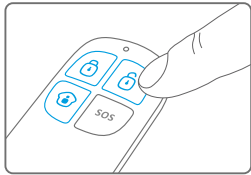

Press . All sensors in the normal group will be activated. All sensors in the home group will be inactive. This means you can partially arm the house.

Mute mode



Press and hold the  for 1 second, and then press  or  within 3 seconds. The alarm system will be armed or disarmed without making any noise. The alarm system can be controlled without disturbing fellow residents.

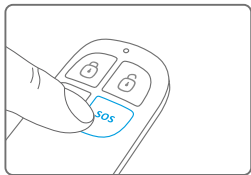

Emergency call

SOS



Regardless whether the alarm system is armed or disarmed, by pressing the **SOS** button on the remote control the alarm will be activated immediately.

Connect a new remote control

Enter the password on the control panel and press the  button. The  button lights up. Press a button on the remote control to connect with the control panel. The control panel will beep once when paired successfully. It will beep twice when it has already been paired before.

Pet-Immune PIR Motion Detector

PIR motion detector overview

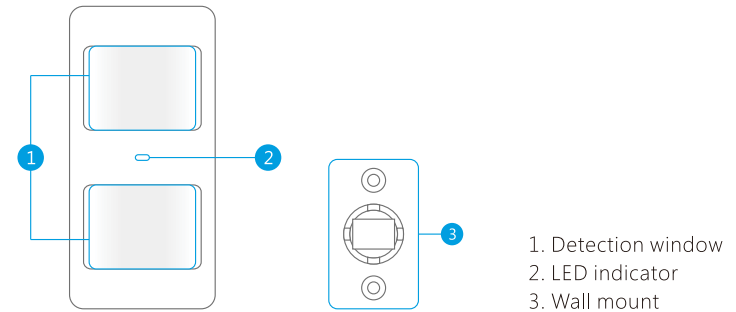

LED indicator

Blink continuously	: Motion detector performs a self-testing
Blink once	: Motion detected
Blink twice	: 3 minutes testing is finished, enters power saving mode.
Blink once every 3 seconds	: Low battery indication, please change the batteries immediately.

Note: When battery level is low it will send an SMS message for notification.

Inside PIR motion detector

Carefully remove the front from the back.

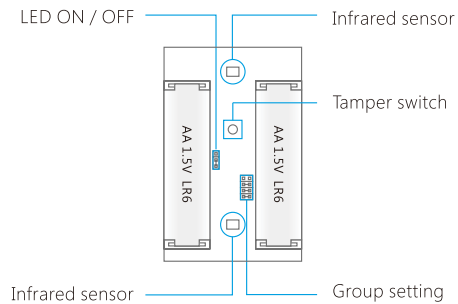

Infrared sensors

The infrared sensors detect movement. These sensors must therefore always be clean.

Do not touch the sensor!

Tamper switch

When opening the housing of the PIR motion detector the tamper switch will be triggered and send a signal to the control panel.

LED On/Off

The LED indicator at the front of the PIR motion detector can be turned off or on by moving the bridges.

Rearside PIR motion detector

Test mode

After self-testing, press the test button once. The PIR motion detector will emit a detection signal (LED flash once).

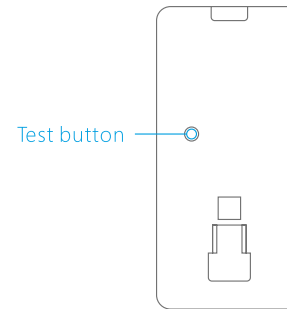

Power saving mode

When the PIR motion detector is triggered 2 times in 3 minutes it automatically goes into power saving mode. When no movement detected in the next 3 minutes it will set itself back to working mode. During the 3 minutes the detector won't be activated and will not send a signal to the control panel. As long as motion is detected within the 3 minutes the power saving mode will be extended for another 3 minutes.

Connecting wireless PIR motion detector

IMPORTANT: When pairing the PIR motion sensor make sure other sensors won't be triggered. Cover other motion sensors or put them temporarily in a room where there is no movement.

Enter the password on the control panel and press the  button. The  button will light up. Now press the test button at the back of the motion sensor two times. The control panel will beep once when pairing is successful. If the system beeps twice, this means that the sensor already has been paired.

Installing PIR motion detector

Avoid installing the motion detector directly toward windows, near airconditioning, heating, refrigerator, oven, direct sunlight and places where many temperature fluctuations occur. Also try to avoid placing two motion detectors in the opposite of each other; don't place it in each others detection range.

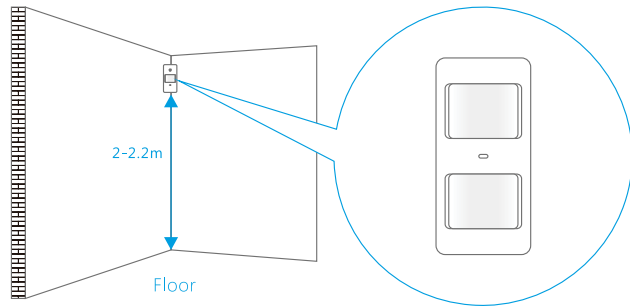

Note: The ideal mounting height of the motion detector is 2-2.2 meters from the floor.

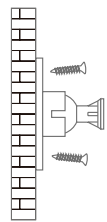

Mount the bracket with the included screws as shown in the figure on the left. Then place the motion detector in the bracket. Specify the right direction of the detection range of the motion sensor. Test the operation of the motion detector by putting it into testing mode which is described at the former page.

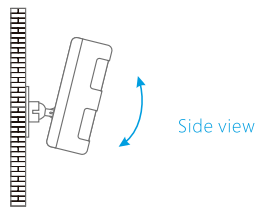

Side view

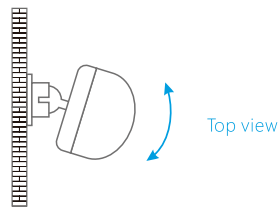

Top view

IMPORTANT: If pet-immune function is used, the detector must be parallel to the wall, do not adjust the angle up or down.

Test mode PIR motion detector

1. Once the motion detector is fully installed and active, the detector can be tested. Press the test button once and walk from left to right or right to left in the room.
2. The LED indicator will flash once when motion is detected.
3. Adjust the angle of the motion detector if needed to obtain the best results. Repeat step 1 and 2 to test the new angle.

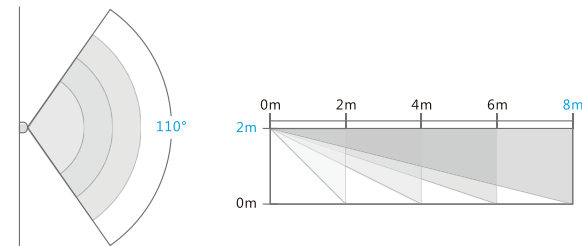

Top view

Side view

Wireless Door/Window Contact

Front view door/window contact

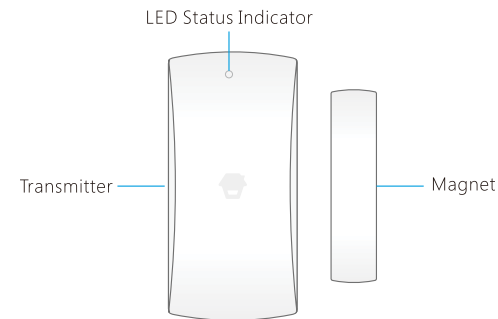

LED indicator

- Blink once** : Door/window open detected
Blink once per 3 seconds : Low battery indication, please change the batteries immediately.

Note: When battery level is low you will receive an SMS for notification.

Inside the door/window contact

Tamper switch

When opening the housing of the door/window contact the tamper switch will be triggered and send a signal to the control panel.

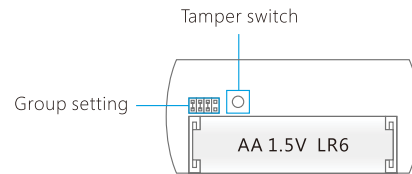

Installation tips

The door/window sensor can be installed on doors, windows or any other objects that can be opened or closed. When installing it on a windows, the sensor (large part) can be applied to the frame and the magnet on the window itself.

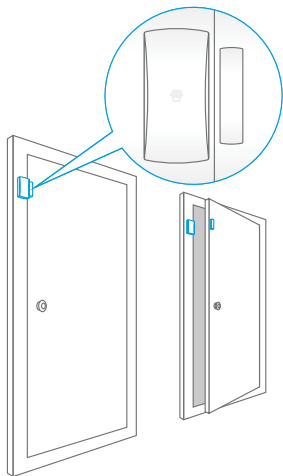

The LED indicator must blink once when the transmitter and magnet are being separated more than one centimeter.

The distance between the transmitter and magnet must not be over one centimeter in closed position.

Apply both parts with the included double-sided tape. It is also possible to apply the contact with screws.

It is not recommended placing door/window contact in areas with a lot of metal. This also applies to a surface with a lot of metal. Always check if the LED indicator blinks when opening the door or window.

IMPORTANT: On both parts there can be found a triangle which should be pointing towards each other.

Connecting magnet contact

1. Make sure the magnet is placed next to the transmitter (within 1 centimeter).
2. Enter the password on the control panel and press button.
3. The button will light up.
4. Separate the transmitter and magnet more than 1 cm from each other.
5. The sensor will be triggered.
The control panel will beep once when connecting is successfully. If the system beeps twice the sensor has already been connected.

Electric Lock Output

The connector of PUSH and GND of the electric lock should be connected to the output connector of PUSH and GND at the bottom of the control panel.

When disarming the system with the control panel connected to an electric lock, the control panel will send a signal and the lock will be opened automatically.

Note: The door which is equipped with electric lock will open automatically if there is a power failure. It is suggested that backup power supply should be provided for electric lock to prevent from power failure.

Installing Control Panel

The control panel can be mounted to the wall or can be put on a bracket on a desk with the included accessories showed below.



Desk stand

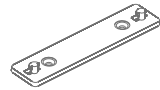

Wall mount

Wall mount

When mounting the control panel to the wall, first apply the wall mount to the wall with included screws. Now you can slide the control panel into the wall mount top to bottom on the plugs. The wall mount secures the tamper switch.

Desk stand

With the desk stand it is possible to place the control panel on a flat surface. The desk stand can be mounted on the control panel by sliding it from top to bottom.

IMPORTANT: Avoid pressing the tamper switch several times in a row, this may cause the system to reset.

Technical Specifications

Control panel

Power Supply	12V DC 500mA
3G/WCDMA Frequency	EU: 900/2100MHz USA: 850/1900MHz AU&NZ: 850/2100MHz
Standby Current	< 180mA
Alarm Current	< 240mA
Transmitting Distance	< 80m(open area/no interface)
Back-up Battery	Lithium-Ion battery 3,7V 800mA BL-5B (2x)
Built-in Siren	95dB
Maximum Wireless Accessories	10 x Remote control 50 x Sensor 50 x RFID Tag
Radio Frequency	315MHz or 433.92MHz (± 75 MHz)
Housing Material	ABS plastic+Acrylic
Temperature	0 to +55 degrees celcius
Relative Humidity	< 80% (non-condensing)
Dimensions (LxWxH)	188 x 132 x 26 mm

PIR-910 Wireless PIR Motion Detector

Power Supply	3V DC (2 x AA 1,5V LR6)
Standby Current	< 18uA
Alarm Current	< 12mA
Detection Range	8 m / 110°
Pet Immunity	< 25kg
Wireless Transmitting Distance	< 80 m (open field/no interference)
Radio Frequency	315MHz or 433.92MHz (\pm 75MHz)
Housing Material	ABS plastic
Temperature	0 to +55 degrees celcius
Relative Humidity	< 80% (non-condensing)
Dimensions Detector	108 x 52 x 36.8 mm
Dimensions Bracket	52 x 30 x 26.5 mm

DWC-102 Wireless Door/Window Contact

Power Supply	1,5V DC (1 x AA 1,5V LR6)
Standby Current	< 35uA
Alarm Current	< 40mA
Wireless Transmitting Distance	< 80 m (open field/no interference)
Radio Frequency	315MHz or 433.92MHZ(\pm 75 MHz)
Housing Material	ABS plastic
Temperature	0 to +55 degrees celcius
Relative Humidity	< 80% (non-condensing)
Dimensions Transmitter	71 x 34 x 17.5 mm
Dimensions Magnet	51 x 12 x 13.5 mm

RC-80 Wireless Remote Control

Power Supply	DC 3V (one CR2025 button cell battery)
Transmit Current	< 7mA
Wireless Transmitting Distance	< 80 m (open field/no interference)
Radio Frequency	315MHz or 433.92MHz (± 75 MHz)
Housing Material	ABS+PC plastic
Temperature	0 to +55 degrees celcius
Relative Humidity	< 80% (non-condensing)
Dimensions	58 x 31 x 9.5mm

TAG-26 (RFID tag)

Circuit	EM4100 CMOS
Radio Frequency	125KHz
Dimensions	30 x 30 x 6mm

Electrical products should not be discarded with household products. According to the European Directive 2002/96/EC on waste electrical and electronic equipment and its implementation into national law, electrical products used must be collected separately and disposed of at collection points provided for this purpose.

Talk with your local authorities or dealer for advice on recycling.

CAUTION: RISK OF EXPLOSION IF BATTERY IS REPLACED BY AN INCORRECT BATTERY TYPE. DISPOSE OF USED BATTERIES ACCORDING TO THE INSTRUCTIONS.

Troubleshooting

When the G5W alarm system is not working properly please try following solutions:

Problems	Reason/Solution
The control panel cannot start up	Confirm whether the power supply is connected correctly
	Make sure the power is on
Remote control does not work	Check whether the indicator on the remote control is on when pressing
	Check whether the remote control has paired to the control panel successfully
	The distance between the control panel and the remote control is too far away
Door/window contact does not work	Check whether the LED indicator is on when magnetic separates from transmitter
	Door/window contact is far away from the control panel
	Check whether the system is in armed state
	Check whether space between the magnet and transmitter is within 1 cm
The PIR detector is triggered but the control panel does not alarm	Press the test button of the detector continuously in armed state. If the control panel does not alarm, please re-pair the PIR to the control panel
	The detector is far away from the control panel
	Check if the detector has entered sleeping state
	Check if the battery is exhausted

Troubleshooting

The control panel does not response to SMS instruction	Make sure the inserting direction of SIM card is right
	Make sure inserting the SIM card first before powering on
	Check whether the SIM card has balance credit
	Check whether the SIM card has enabled Caller ID Display function, text function
Do not receive phone calls when alarm	Check whether the alarm notification number has been stored
	After alarm, do not disarm the system immediately otherwise the system will stop calling
	Check whether the SIM card has balance credit
No sound when sending out alarm	Check if control panel volume is set as mute; Reset alarm ring volume by SMS or APP
Lifespan of the battery in door/window contact	The door magnet itself has one AA battery, and its service life is approximately 8-12 months. For example: as for a family of three people who go out early and come home late without anyone at home in the daytime, its standby time is 12 months; places having large flow of people every day that need open and close doors frequently, such as stores, it could be used for around 8 months
Lifespan of the battery in PIR motion detector	The detector itself has two AA batteries whose service life is approximately 8-12 months. For example: as for a family of three people who go out early and come home late without anyone at home in the daytime, its service life is 12 months; as for places having large flow of people every day, such as stores, its service life is about 8 months
No response when swiping RFID tags	RFID function can be used only after the control panel is connected to the power adapter
	Check if the RFID tag is paired to the control panel. If not, please pair it again

Swiping RFID tags without sending SMS notification	Check if RFID SMS notification number and RFID tags name are stored
The detector, remote control and other accessories do not response any more after the control panel is moved	Long press the tamper switch for 4 seconds and then quick press the tamper switch 5 times in 3 seconds, and all the connection between the control panel and accessories will be cleared. Pay attention not to trigger the tamper switch frequently when installing the control panel
Get replied SMS "Phone number is unauthorized."	Whether the SIM card has enabled Caller ID Display function
	Whether the cell phone number is set as alarm number
Network indicator blinks	When the network indicator stays on, means the network is being searched. When the indicator blinks once every second a network has been found.
Motion detector doesn't seem to work properly	When the PIR motion detector is triggered 2 times in 3 minutes it automatically goes into power saving mode. When no movement has been detected in the next 3 minutes it will set itself in the normal mode. During the 3 minutes the detector won't be active and will not send a signal to the control panel. As long as motion is detected within the 3 minutes the power saving mode will be extended.